

P5VD2-MX SE

User Guide

ASUS[®]

Motherboard

E2977

First Edition

January 2007

Copyright © 2007 ASUSTeK COMPUTER INC. All Rights Reserved.

No part of this manual, including the products and software described in it, may be reproduced, transmitted, transcribed, stored in a retrieval system, or translated into any language in any form or by any means, except documentation kept by the purchaser for backup purposes, without the express written permission of ASUSTeK COMPUTER INC. ("ASUS").

Product warranty or service will not be extended if: (1) the product is repaired, modified or altered, unless such repair, modification or alteration is authorized in writing by ASUS; or (2) the serial number of the product is defaced or missing.

ASUS PROVIDES THIS MANUAL "AS IS" WITHOUT WARRANTY OF ANY KIND, EITHER EXPRESS OR IMPLIED, INCLUDING BUT NOT LIMITED TO THE IMPLIED WARRANTIES OR CONDITIONS OF MERCHANTABILITY OR FITNESS FOR A PARTICULAR PURPOSE. IN NO EVENT SHALL ASUS, ITS DIRECTORS, OFFICERS, EMPLOYEES OR AGENTS BE LIABLE FOR ANY INDIRECT, SPECIAL, INCIDENTAL, OR CONSEQUENTIAL DAMAGES (INCLUDING DAMAGES FOR LOSS OF PROFITS, LOSS OF BUSINESS, LOSS OF USE OR DATA, INTERRUPTION OF BUSINESS AND THE LIKE), EVEN IF ASUS HAS BEEN ADVISED OF THE POSSIBILITY OF SUCH DAMAGES ARISING FROM ANY DEFECT OR ERROR IN THIS MANUAL OR PRODUCT.

SPECIFICATIONS AND INFORMATION CONTAINED IN THIS MANUAL ARE FURNISHED FOR INFORMATIONAL USE ONLY, AND ARE SUBJECT TO CHANGE AT ANY TIME WITHOUT NOTICE, AND SHOULD NOT BE CONSTRUED AS A COMMITMENT BY ASUS. ASUS ASSUMES NO RESPONSIBILITY OR LIABILITY FOR ANY ERRORS OR INACCURACIES THAT MAY APPEAR IN THIS MANUAL, INCLUDING THE PRODUCTS AND SOFTWARE DESCRIBED IN IT.

Products and corporate names appearing in this manual may or may not be registered trademarks or copyrights of their respective companies, and are used only for identification or explanation and to the owners' benefit, without intent to infringe.

Contents

Notices	vi
Safety information	vii
P5VD2-MX SE specifications summary	viii
Chapter 1: Product Introduction	
1.1 Welcome!	1-2
1.2 Package contents	1-2
1.3 Special features	1-2
1.3.1 Product highlights	1-2
1.3.2 ASUS unique features	1-4
1.4 Before you proceed	1-5
1.5 Motherboard overview	1-6
1.5.1 Motherboard layout	1-6
1.5.2 Placement direction	1-7
1.5.3 Screw holes	1-7
1.6 Central Processing Unit (CPU)	1-8
1.6.1 Overview	1-8
1.6.2 Installing the CPU	1-8
1.7 System memory	1-10
1.7.1 Overview	1-10
1.7.2 Memory configurations	1-10
1.7.3 Installing a DIMM	1-13
1.7.4 Removing a DIMM	1-13
1.8 Expansion slots	1-14
1.8.1 Installing an expansion card	1-14
1.8.2 Configuring an expansion card	1-14
1.8.3 PCI slots	1-16
1.8.4 PCI Express x 1 slot	1-16
1.8.5 PCI Express x 16 slot	1-16
1.9 Jumpers	1-17
1.10 Connectors	1-19
1.10.1 Rear panel connectors	1-19
1.10.2 Internal connectors	1-20

Contents

Chapter 2: BIOS Information

- 2.1 Managing and updating your BIOS.....2-2
 - 2.1.1 Creating a bootable floppy disk.....2-2
 - 2.1.2 Using AFUDOS to copy the current BIOS.....2-2
 - 2.1.3 Using AFUDOS to update the BIOS.....2-3
 - 2.1.4 Recovering the BIOS with CrashFree BIOS 2.....2-5
 - 2.1.5 Using ASUS EZ Flash to update the BIOS.....2-7
- 2.2 BIOS Setup program2-8
 - 2.2.1 BIOS menu screen.....2-9
 - 2.2.2 Menu bar2-9
 - 2.2.3 Navigation keys.....2-9
 - 2.2.4 Menu items.....2-10
 - 2.2.5 Sub-menu items.....2-10
 - 2.2.6 Configuration fields.....2-10
 - 2.2.7 Pop-up window.....2-10
 - 2.2.8 Scroll bar2-10
 - 2.2.9 General help.....2-10
- 2.3 Main menu2-11
 - 2.3.1 System Time2-11
 - 2.3.2 System Date2-11
 - 2.3.3 Legacy Diskette A/B2-11
 - 2.3.4 Primary, Secondary, Third, Fourth IDE Master/Slave...2-12
 - 2.3.5 IDE Configuration.....2-13
 - 2.3.6 System Information2-14
- 2.4 Advanced menu.....2-15
 - 2.4.1 CPU Configuration2-15
 - 2.4.2 Chipset.....2-16
 - 2.4.3 Onboard Devices Configuration2-23
 - 2.4.4 PCI PnP.....2-24
- 2.5 Power menu.....2-25
 - 2.5.1 ACPI 2.0 Support2-25
 - 2.5.2 ACPI APIC Support.....2-25
 - 2.5.3 APM Configuration.....2-26
 - 2.5.4 Hardware Monitor.....2-28
- 2.6 Boot menu2-29
 - 2.6.1 Boot Device Priority.....2-30
 - 2.6.2 Boot Settings Configuration.....2-31
 - 2.6.3 Security2-32
- 2.7 Exit menu.....2-33

Contents

Chapter 3: Software Support

3.1	Installing an operating system	3-2
3.2	Support CD information	3-2
3.2.1	Running the support CD.....	3-2
3.2.2	Drivers menu	3-3
3.2.3	Utilities menu.....	3-3
3.2.4	Make disk menu	3-5
3.2.5	Manuals menu.....	3-5
3.2.6	ASUS contact information	3-6

Notices

Federal Communications Commission Statement

This device complies with Part 15 of the FCC Rules. Operation is subject to the following two conditions:

- This device may not cause harmful interference, and
- This device must accept any interference received including interference that may cause undesired operation.

This equipment has been tested and found to comply with the limits for a Class B digital device, pursuant to Part 15 of the FCC Rules. These limits are designed to provide reasonable protection against harmful interference in a residential installation. This equipment generates, uses and can radiate radio frequency energy and, if not installed and used in accordance with manufacturer's instructions, may cause harmful interference to radio communications. However, there is no guarantee that interference will not occur in a particular installation. If this equipment does cause harmful interference to radio or television reception, which can be determined by turning the equipment off and on, the user is encouraged to try to correct the interference by one or more of the following measures:

- Reorient or relocate the receiving antenna.
- Increase the separation between the equipment and receiver.
- Connect the equipment to an outlet on a circuit different from that to which the receiver is connected.
- Consult the dealer or an experienced radio/TV technician for help.



To assure compliance with FCC regulations, use shielded cables to connect the monitor to the graphics card. Changes to this unit not expressly approved by the party responsible for compliance can void the user's authority to operate this equipment.

Canadian Department of Communications Statement

This digital apparatus does not exceed the Class B limits for radio noise emissions from digital apparatus set out in the Radio Interference Regulations of the Canadian Department of Communications.

This class B digital apparatus complies with Canadian ICES-003.

Safety Information

Electrical safety

- To prevent electrical shock hazard, disconnect the power cable from the electrical outlet before relocating the system.
- When adding or removing devices to or from the system, ensure that the power cables for the devices are unplugged before the signal cables are connected. If possible, disconnect all power cables from the existing system before you add a device.
- Before connecting or removing signal cables from the motherboard, ensure that all power cables are unplugged.
- Seek professional assistance before using an adapter or extension cord. These devices can interrupt the grounding circuit.
- Set your power supply to the correct voltage in your area. If you are not sure about the voltage of the electrical outlet you are using, contact your local power company.
- If the power supply is broken, do not try to fix it by yourself. Contact a qualified service technician or your retailer.

Operational safety

- Before installing the motherboard and adding devices on it, carefully read all the manuals that came with the package.
- Before using the product, make sure all cables are correctly connected and the power cables are not damaged. If you detect any damage, contact your dealer immediately.
- To avoid short circuits, keep paper clips, screws, and staples away from connectors, slots, sockets, and circuitry.
- Avoid dust, humidity, and temperature extremes. Do not place the product in any area where it can get wet.
- Place the product on a stable surface.
- If you encounter technical problems with the product, contact a qualified service technician or your retailer.



The symbol of the crossed out wheeled bin indicates that the product (electrical and electronic equipment) should not be placed in municipal waste. Check local regulations for disposal of electronic products.

P5VD2-MX SE Specifications Summary

CPU	LGA775 socket for Intel® Core™2 Extreme / Core™2 Duo / Pentium® D / Pentium® 4 / Celeron® D Processors Compatible with Intel® 06/05B/05A processors Supports Enhanced Intel SpeedStep® Technology (EIST), and Intel® Hyper-Threading Technology
Chipset	Northbridge: VIA P4M890 Southbridge: VIA VT8237A
System bus	1066/800/533 MHz
Memory	2 x 240-pin DDR2 DIMM sockets for up to 2 GB unbuffered DDR2 533 DRAM memory
Expansion slots	1 x PCI Express x16 slot for discrete graphics card 1 x PCI Express x1 2 x PCI slots
Storage	VIA VT8237A SouthBridge supports: - 2 x Ultra DMA 133/100/66/33 for four IDE devices - 2 x Serial ATA with RAID 0, RAID 1, and JBOD configurations
Audio	Realtek® ALC660 6-channel CODEC
LAN	Realtek® RTL8201CL 10/100M LAN PHY
USB 2.0	Supports up to 8 USB 2.0 ports
Rear panel I/O ports	1 x Parallel port 1 x Serial port 1 x PS/2 keyboard port 1 x PS/2 mouse port 1 x VGA port 1 x Audio I/O port 1 x LAN (RJ-45) port 4 x USB 2.0 ports
Internal I/O connectors	2 x USB connectors support four additional USB ports 1 x 24-pin ATX power connector 1 x 4-pin ATX 12V power connector 1 x CD audio in connector 1 x Speaker out connector 1 x Front panel audio connector CPU/Chassis fan connectors 1 x System panel connector

(Continued on the next page)

P5VD2-MX SE Specifications Summary

BIOS features	4Mb Flash ROM, AMI BIOS, PnP, DMI2.0, WfM2.0, ACPI 2.0, SM BIOS 2.3, ASUS EZ Flash, ASUS MyLogo
ASUS special features	ASUS MyLogo ASUS EZ Flash ASUS CrashFree BIOS 2
Manageability	WOR by PME, WOL by PME, WOR by Ring
Support CD	Device drivers ASUS PC Probe II ASUS Update
Form factor	MicroATX 9.6" x 7.2"VCT (24.5cm x 19.2cm)

*Specifications are subject to change without notice.

Chapter 1

This chapter describes the features of this motherboard. It includes brief explanations of the special attributes of the motherboard and the new technology it supports.

Product Introduction

1.1 Welcome!

Thank you for buying the ASUS® P5VD2-MX SE motherboard!

The ASUS P5VD2-MX SE motherboard delivers a host of new features and latest technologies making it another standout in the long line of ASUS quality motherboards!

Before you start installing the motherboard, and hardware devices on it, check the items in your package with the list below.

1.2 Package Contents

Check your P5VD2-MX SE package for the following items.

- ✓ ASUS P5VD2-MX SE motherboard
- ✓ ASUS motherboard support CD
- ✓ 1 x Ultra DMA 133/100/66 cable
- ✓ 1 x Serial ATA cable kit (SATA/Power)
- ✓ 1 x FDD cable
- ✓ I/O shield
- ✓ P5VD2-MX SE user guide



If any of the above items is damaged or missing, contact your retailer.

1.3 Special Features

1.3.1 Product highlights



Intel® Core™2 Processor Ready

This motherboard supports the latest Intel® Core™2 processor in the LGA775 package. With the new Intel® Core™ microarchitecture technology and 1066 / 800 MHz FSB, Intel® Core™2 processor is one of the most powerful and energy efficient CPU in the world.



Intel® Dual/Single-Core 65nm Processors

This motherboard supports Intel® 65nm Pentium® D / Intel® Pentium® 4 / Celeron® processors. ASUS motherboard is the ideal solution to enhance the performance of new generation processors.

VT8237A chipset



The VT8237A Southbridge employs the VIA DriveStation™ Controller Suite that enables multiple drive configuration through native Serial ATA, RAID, and Parallel ATA/133 support. This chip also supports USB 2.0, MC97, PCI and LPC interfaces and allows 6-channel audio through the VIA Vinyl Audio technology. When Serial ATA installing OS, there is no need to set up drive.

DDR2 memory support



The motherboard supports DDR2 memory which features data transfer rates of 533 MHz to meet the higher bandwidth requirements of the latest 3D graphics, multimedia, and Internet applications. With initial speeds from 400 and 533 MHz, DDR2 memory provides bandwidth up to 4.3 GB/s. See pages 1-15 to 1-18 for details.

PCI Express™ interface



The motherboard fully supports PCI Express, the latest I/O interconnect technology that speeds up the PCI bus. PCI Express features point-to-point serial interconnections between devices and allows higher clocks speeds by carrying data in packets. This high speed interface is software compatible with existing PCI specifications. See page 1-22 for details.

Integrated 10/100 Mbps LAN



The on-board LAN controller is a highly integrated FAST Ethernet controller. It is enhanced with an ACPI management function to provide efficient power management for advanced operating systems.

USB 2.0 technology



USB 2.0 is the latest connectivity standard for next generation components and peripherals. Backwards compatible with current USB 1.1 peripherals, USB 2.0 delivers transfer speeds up to 40 times faster at 480MB/s, for easy connectivity.

Serial ATA RAID



The on board VT8237A southbridge provides the complete solution for your RAID requirements on different disk array standards, and supports RAID 0, RAID 1 and JBOD configurations on two Serial ATA ports.

1.3.2 ASUS unique features

EZ Flash BIOS

With the ASUS EZ Flash, you can easily update the system BIOS even before loading the operating system. No need to use a DOS-based utility or boot from a floppy disk. See page 2-7.

CrashFree BIOS 2

Whenever BIOS gets corrupted, ASUS CrashFree BIOS2 allows users to reboot the computer and perform an smart auto-recovery procedure through the motherboard support CD. See page 2-5.

ASUS MyLogo™

This feature allows you to personalize and add style to your system with customizable boot logos. See pages 2-31.

1.4 Before You Proceed

Take note of the following precautions before you install motherboard components or change any motherboard settings.



- Unplug the power cord from the wall socket before touching any component.
- Use a grounded wrist strap or touch a safely grounded object or a metal object, such as the power supply case, before handling components to avoid damaging them due to static electricity.
- Hold components by the edges to avoid touching the ICs on them.
- Whenever you uninstall any component, place it on a grounded antistatic pad or in the bag that came with the component.
- Before you install or remove any component, ensure that the ATX power supply is switched off or the power cord is detached from the power supply. Failure to do so may cause severe damage to the motherboard, peripherals, and/or components.

Onboard LED

The motherboard comes with a standby power LED that lights up to indicate that the system is ON, in sleep mode, or in soft-off mode. This is a reminder that you should shut down the system and unplug the power cable before removing or plugging in any motherboard component.

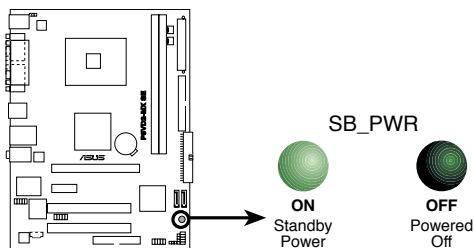

P5VD2-MX SE Onboard LED

1.5 Motherboard Overview

1.5.1 Motherboard layout

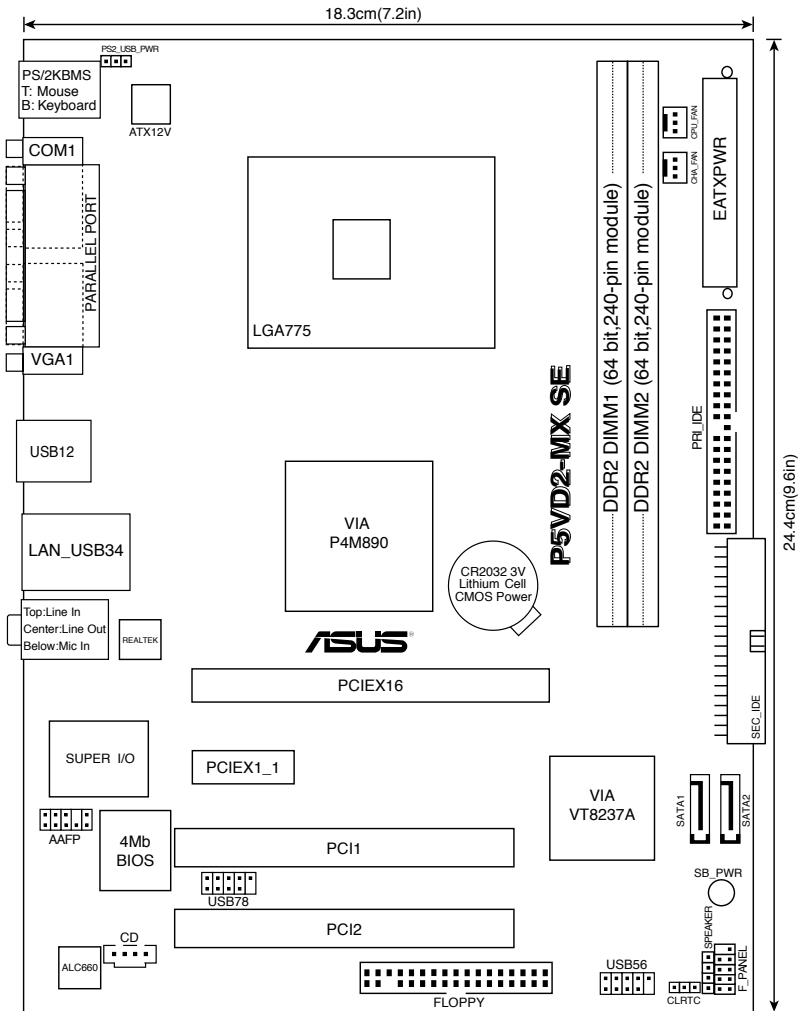

1.5.2 Placement direction

When installing the motherboard, make sure that you place it into the chassis in the correct orientation. The edge with external ports goes to the rear part of the chassis as indicated in the image below.

1.5.3 Screw holes

Place six (6) screws into the holes indicated by circles to secure the motherboard to the chassis.



Do not overtighten the screws! Doing so may damage the motherboard.

Place this side
towards
the rear of the
chassis

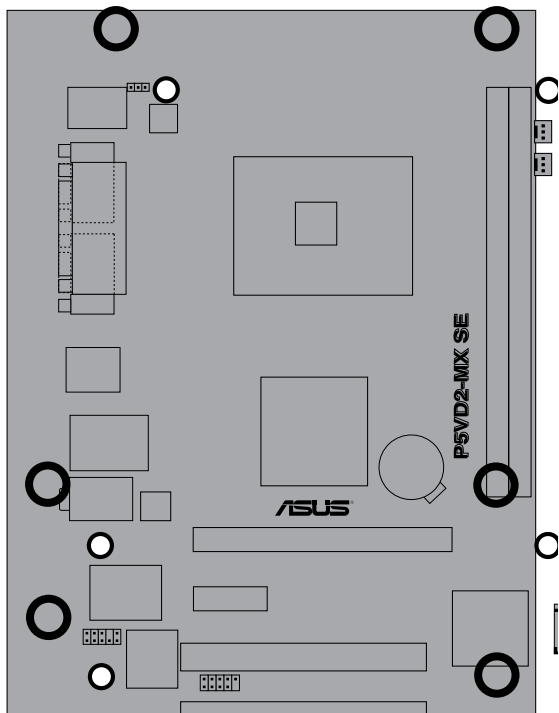

1.6 Central Processing Unit (CPU)

The motherboard comes with a surface mount LGA775 socket designed for the Intel® Core™2 Extreme / Core™2 Duo / Pentium® D / Pentium® 4 / Celeron® D Processors.



- Your boxed Intel® Core™2 Extreme / Core™2 Duo / Pentium® D / Pentium® 4 / Celeron® D Processors package should come with installation instructions for the CPU, fan and heatsink assembly. If the instructions in this section do not match the CPU documentation, follow the latter.
- Upon purchase of the motherboard, make sure that the PnP cap is on the socket and the socket pins are not bent. Contact your retailer immediately if the PnP cap is missing, or if you see any damage to the PnP cap/socket pins/motherboard components. ASUS will shoulder the cost of repair only if the damage is shipment/transit-related.
- Keep the cap after installing the motherboard. ASUS will process Return Merchandise Authorization (RMA) requests only if the motherboard comes with the cap on the LGA775 socket.
- The product warranty does not cover damage to the socket pins resulting from incorrect CPU installation/removal, or misplacement/loss/incorrect removal of the PnP cap.

1.6.1 Installing the CPU

To install a CPU:

1. Locate the CPU socket on the motherboard.

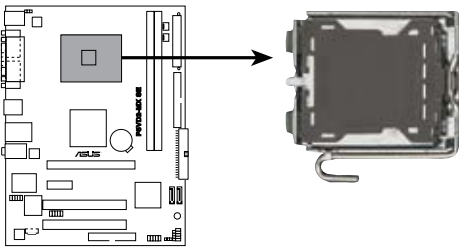

P5VD2-MX SE CPU Socket 775



Before installing the CPU, make sure that the socket box is facing towards you and the load lever is on your left.

2. Press the load lever with your thumb (A) and move it to the left (B) until it is released from the retention tab.

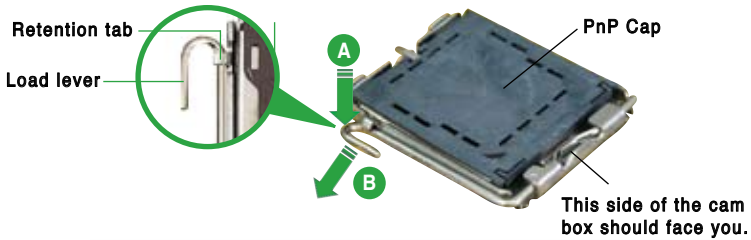

To prevent damage to the socket pins, do not remove the PnP cap unless you are installing a CPU.

3. Lift the load lever in the direction of the arrow to a 135° angle.

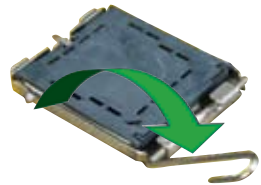

4. Lift the load plate with your thumb and forefinger to a 100° angle (A), then push the PnP cap from the load plate window to remove (B).

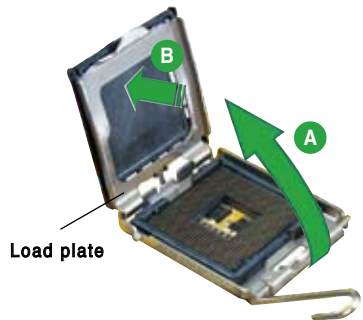

5. Position the CPU over the socket, making sure that the gold triangle is on the bottom-left corner of the socket. The socket alignment key should fit into the CPU notch.

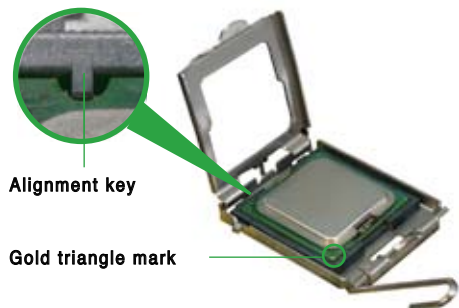

6. Close the load plate (A), then push the load lever (B) until it snaps into the retention tab.



The CPU fits in only one correct orientation. DO NOT force the CPU into the socket to prevent bending the connectors on the socket and damaging the CPU!



The motherboard supports Intel® LGA775 processors with the Intel® Enhanced Memory 64 Technology (EM64T), Enhanced Intel SpeedStep® Technology (EIST), and Hyper-Threading Technology.



If you install a dual-core CPU, make sure to connect the chassis fan cable to CHA_FAN connector for system stability.

1.6.2 Installing the CPU heatsink and fan

The Intel® Core™2 Extreme / Core™2 Duo / Pentium® D / Pentium® 4 / Celeron® D Processors require a specially designed heatsink and fan assembly to ensure optimum thermal condition and performance.



- Install the motherboard to the chassis before you install the CPU fan and heatsink assembly
- When you buy a boxed Intel® Core™2 Extreme / Core™2 Duo / Pentium® D / Pentium® 4 / Celeron® D LGA775 processor, the package includes the CPU fan and heatsink assembly. If you buy a CPU separately, make sure that you use only Intel®-certified multi-directional heatsink and fan.
- Your Intel® Core™2 Extreme / Core™2 Duo / Pentium® D / Pentium® 4 / Celeron® D LGA775 heatsink and fan assembly comes in a push-pin design and requires no tool to install.



If you purchased a separate CPU heatsink and fan assembly, make sure that a Thermal Interface Material is properly applied to the CPU heatsink or CPU before you install the heatsink and fan assembly.

To install the CPU heatsink and fan:

1. Place the heatsink on top of the installed CPU, making sure that the four fasteners match the holes on the motherboard.

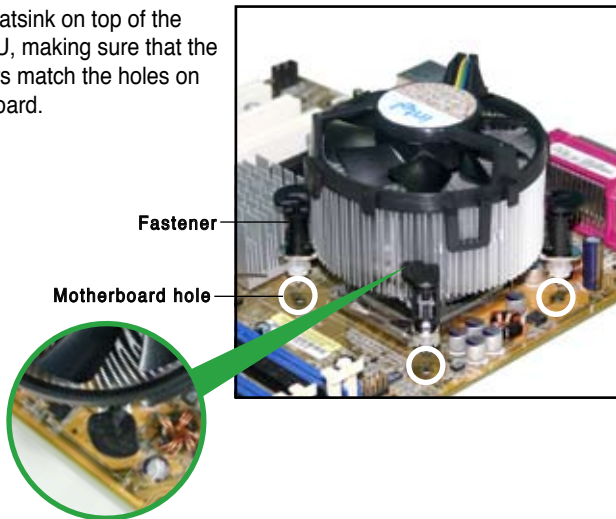

Make sure each fastener is oriented as shown, with the narrow groove directed outward.

2. Push down two fasteners at a time in a diagonal sequence to secure the heatsink and fan assembly in place.

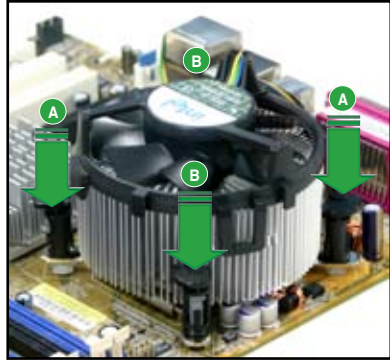
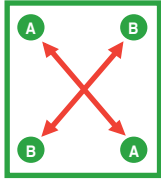

3. When the fan and heatsink assembly is in place, connect the CPU fan cable to the connector on the motherboard labeled CPU_FAN.

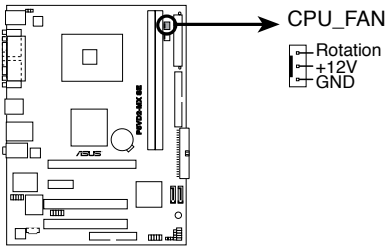

P5VD2-MX SE CPU Fan Connector



Do not forget to connect the CPU fan connector! Hardware monitoring errors can occur if you fail to plug this connector.

1.6.3 Uninstalling the CPU heatsink and fan

To uninstall the CPU heatsink and fan:

1. Disconnect the CPU fan cable from the connector on the motherboard.
2. Rotate each fastener counterclockwise.

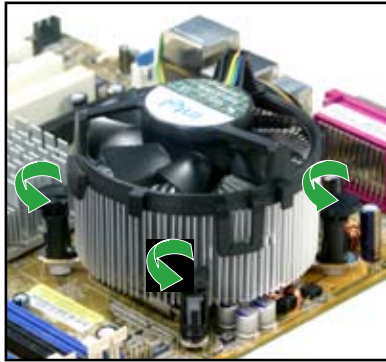

3. Pull up two fasteners at a time in a diagonal sequence to disengage the heatsink and fan assembly from the motherboard.

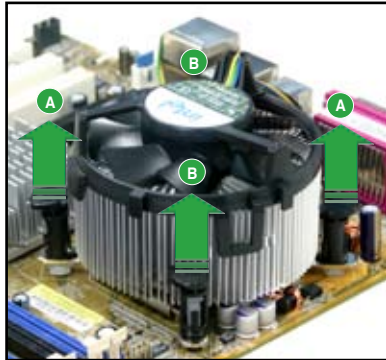
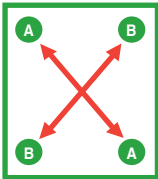

- 4. Remove the heatsink and fan assembly from the motherboard.



- 5. Rotate each fastener clockwise to reset the orientation.

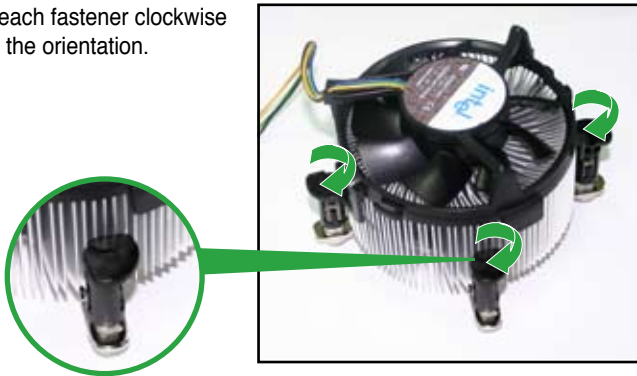

Narrow end of the groove



The narrow end of the groove should point outward after resetting. (The photo shows the groove shaded for emphasis.)



1.7 System memory

1.7.1 Overview

The motherboard comes with two Double Data Rate 2 (DDR2) Dual Inline Memory Modules (DIMM) sockets.

A DDR2 module has the same physical dimensions as a DDR DIMM but has a 240-pin footprint compared to the 184-pin DDR DIMM. DDR2 DIMMs are notched differently to prevent installation on a DDR DIMM socket.

The figure illustrates the location of the DDR2 DIMM sockets:

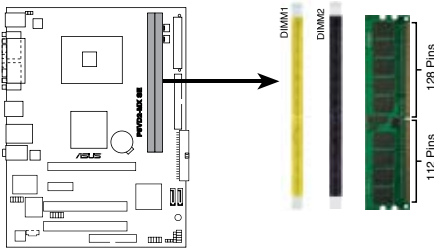

P5VD2-MX SE 240-pin DDR DIMM Sockets

1.7.2 Memory configurations

You may install 256 MB, 512 MB and 1 GB unbuffered DDR2 DIMMs into the DIMM sockets.



For optimum compatibility, we recommend that you obtain memory modules from qualified vendors. See the Qualified Vendors List (QVL) on the next page.

Qualified DDR2 533 DIMMs

The following table lists the DDR2 533 (PC2-4200) memory modules that have been tested and qualified for use with this motherboard.



Obtain DDR DIMMs only from qualified vendors for better system performance.

Size	Vendor	Model	Brand	Side(s)	Component	DIMM support	
						A*	B*
256MB	Kingston	KVR533D2N4/256	Elpida	SS	E5116AB-5C-E	•	•
256MB	Kingston	KVR533D2N4/256	Elpida	SS	E5116AF-5C-E	•	•
512MB	Kingston	KVR533D2N4/512	Hynix	DS	HY5PS56821	•	•
512MB	Kingston	KVR533D2N4/512	Infineon	SS	HYB18T512800AF3733336550	•	•
1G	Kingston	KVR533D2N4/1G	Kingston	DS	D6408TE7BL-37	•	•
1G	Kingston	KVR533D2N4/1G	Micron	DS	5YD11D9GCT	•	•
256MB	Samsung	M378T3253FG0-CD5	Samsung	SS	K4T56083QF-GCD5	•	•
512MB	Samsung	M378T6553BG0-CD5	Samsung	SS	K4T51083Q8-GCD5	•	•
256MB	Infineon	HYS64T32000HU-3.7-A	Infineon	SS	HYB18T512160AF-3.7AFSS31270	•	•
512MB	Infineon	HYS64T64000GU-3.7-A	Infineon	SS	HYB18T512800AC37SS11511	•	•
512MB	Infineon	HYS64T64000HU-3.7-A	Infineon	SS	HYB18T512800AF37FSS29334	•	•
512MB	Infineon	HYS64T64000HU-3.7-A	Infineon	SS	HYB18T512800AF37SS12079	•	•
512MB	Micron	MT 16HTF6464AG-53EB2	Micron	DS	D980M	•	•
512MB	Micron	MT 16HTF6464AG-53EB2	Micron	DS	Z98QT	•	•
1G	Micron	MT 16HTF12864AY-53EA1	Micron	DS	D9CRZ	•	•
512MB	Corsair	V5S12MB533D2	Corsair	DS	MIII0052532M8CEC	•	•
512MB	Elpida	EBE51UD8ABFA-5C-E	Elpida	SS	E5108AB-5C-E	•	•
512MB	Kingmax	KLBC28F-A8KB4	Kingmax	SS	KKEA8884IAK-37	•	•
256MB	Kingmax	KLBB68F-36EP4	Elpida	SS	E5116AB-5C-E	•	•
512MB	Kingmax	KLBC28F-A8EB4	Elpida	SS	E5108AE-5C-E	•	•
512MB	PQI	MEAB-323LA	PQI	SS	D2-E04180W025	•	•
1G	PQI	MEAB-423LA	PQI	DS	D2-E04230W107	•	•
512MB	AENEON	AET660UD00-370A98Z	AENEON	SS	AET93F370A G 0513	•	•
256MB	AENEON	AET560UD00-370A98Z	AENEON	SS	AET94F370AWVV34635G0520	•	•
512MB	AENEON	AET660UD00-370A98Z	AENEON	SS	AET93F370A 3V36328G 0522	•	•
512MB	AENEON	AET660UD00-370A98X	AENEON	SS	AET93F370A 0518	•	•
512MB	AENEON	AET660UD00-370A88S	AENEON	DS	AET82F370A 0550	•	•
1G	AENEON	AET760UD00-370A98Z	AENEON	DS	AET93F370A 0551	•	•
2G	AENEON	AET860UD00-370A08X	AENEON	DS	AET03F370AFV26176G 0542	•	•

Legend:

- A** - Supports one module inserted into either slot as a Single-channel memory configuration.
- B** - Supports two pairs of modules inserted into either the yellow slot or the black slot.
- SS** - Single-sided
- DS** - Double-sided



Visit the ASUS website (www.asus.com) for the latest DDR2 533 Qualified Vendors List.

1.7.4 Installing a DIMM



Unplug the power supply before adding or removing DIMMs or other system components. Failure to do so can cause severe damage to both the motherboard and the components.

To install a DIMM:

1. Unlock a DIMM socket by pressing the retaining clips outward.
2. Align a DIMM on the socket such that the notch on the DIMM matches the break on the socket.
3. Firmly insert the DIMM into the socket until the retaining clips snap back in place and the DIMM is properly seated.

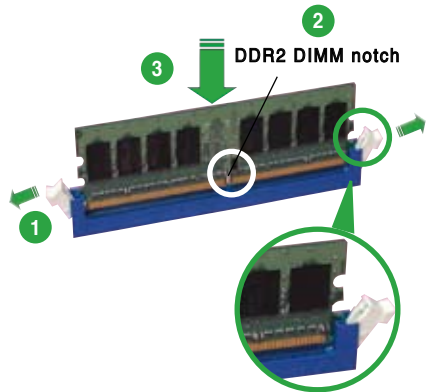

Unlocked retaining clip



- A DDR2 DIMM is keyed with a notch so that it fits in only one direction. Do not force a DIMM into a socket to avoid damaging the DIMM.
- The DDR2 DIMM sockets do not support DDR DIMMs. DO not install DDR DIMMs to the DDR2 DIMM sockets.

1.7.5 Removing a DIMM

Follow these steps to remove a DIMM.

1. Simultaneously press the retaining clips outward to unlock the DIMM.



Support the DIMM lightly with your fingers when pressing the retaining clips. The DIMM might get damaged when it flips out with extra force.

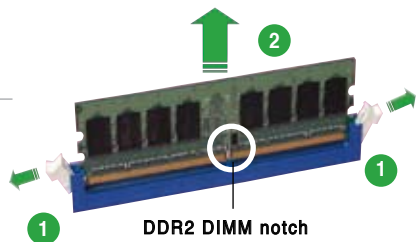

2. Remove the DIMM from the socket.

1.8 Expansion slots

In the future, you may need to install expansion cards. The following sub-sections describe the motherboard slots and the expansion cards that they support.



Make sure to unplug the power cord before adding or removing expansion cards. Failure to do so may cause you physical injury and damage motherboard components.

1.8.1 Installing an expansion card

Follow these steps to install an expansion card.

1. Before installing the expansion card, read the documentation that came with it and make the necessary hardware settings for the card.
2. Remove the system unit cover (if your motherboard is already installed in a chassis).
3. Remove the bracket opposite the slot that you intend to use. Keep the screw for later use.
4. Align the card connector with the slot and press firmly until the card is completely seated on the slot.
5. Secure the card to the chassis with the screw you removed earlier.
6. Replace the system cover.

1.8.2 Configuring an expansion card

After installing the expansion card, configure the card by adjusting the software settings.

1. Turn on the system and change the necessary BIOS settings, if any. See Chapter 2 for information on BIOS setup.
2. Assign an IRQ to the card. Refer to the tables on the next page.
3. Install the software drivers for the expansion card.

Standard Interrupt Assignments

IRQ	Priority	Standard Function
0	1	System Timer
1	2	Keyboard Controller
2	N/A	N/A
3	11	IRQ Holder for PCI Steering
4	12	Communications Port (COM1)
5	13	IRQ Holder for PCI Steering
6	14	Floppy Disk Controller
7	15	Printer Port (LPT1)
8	3	System CMOS/Real Time Clock
9	4	Microsoft ACPI-Compliant System
10	5	IRQ Holder for PCI Steering
11	6	IRQ Holder for PCI Steering
12	7	PS/2 Compatible Mouse Port
13	8	Numeric Data Processor
14	9	Primary IDE Channel
15	10	Secondary IDE Channel

IRQ assignments for this motherboard

	INT A	INT B	INT C	INT D
PCI slot 1	shared	—	—	—
PCI slot 2	—	shared	—	—
OnBoard VGA	shared	—	—	—



When using PCI cards on shared slots, ensure that the drivers support "Share IRQ" or that the cards do not need IRQ assignments; otherwise, conflicts will arise between the two PCI groups, making the system unstable and the card inoperable.

1.8.3 PCI slots

The PCI slots support LAN, SCSI, USB, and other PCI cards that comply with PCI specifications. The figure shows a LAN card installed on a PCI slot.

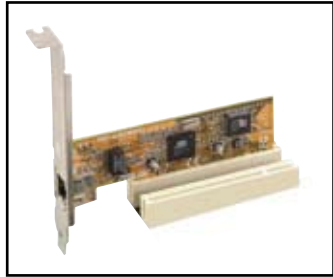

1.8.4 PCI Express x1 slot

This motherboard supports PCI Express x1 network cards, SCSI cards and other cards that comply with the PCI Express specifications. The figure shows a network card installed on the PCI Express x1 slot.



1.8.5 PCI Express x16 slot

This motherboard supports PCI Express x16 graphic cards that comply with the PCI Express specifications. The figure shows a graphics card installed on the PCI Express x16 slot.



1.9 Jumpers

1. Clear RTC RAM (CLRRTC)

This jumper allows you to clear the Real Time Clock (RTC) RAM in CMOS. You can clear the CMOS memory of date, time, and system setup parameters by erasing the CMOS RTC RAM data. The RAM data in CMOS, that include system setup information such as system passwords, is powered by the onboard button cell battery.

To erase the RTC RAM:

1. Turn OFF the computer and unplug the power cord.
2. Remove the onboard battery.
3. Move the jumper cap from pins 1-2 (default) to pins 2-3. Keep the cap on pins 2-3 for about 5~10 seconds, then move the cap back to pins 1-2.
4. Replace the battery.
5. Plug the power cord and turn ON the computer.
6. Hold down the key during the boot process and enter BIOS setup to re-enter data.



Except when clearing the RTC RAM, never remove the cap on the CLRRTC jumper default position. Removing the cap will cause system boot failure!

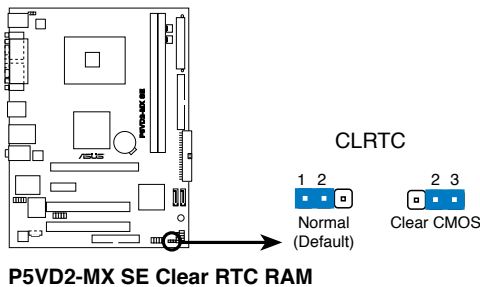

2. USB device wake-up (3-pin PS2_USB_PWR)

Set this jumper to +5V to wake up the computer from S1 sleep mode (CPU stopped, DRAM refreshed, system running in low power mode) using the connected USB devices. Set to +5VSB to wake up from S3 and S4 sleep mode (no power to CPU, DRAM in slow refresh, power supply in reduced power mode).

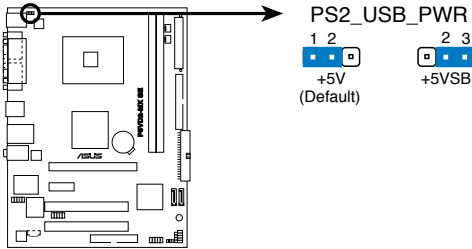

P5VD2-MX SE USB Device Wake Up



- The USB device wake-up feature requires a power supply that can provide 500mA on the +5VSB lead for each USB port; otherwise, the system would not power up.
- The total current consumed must NOT exceed the power supply capability (+5VSB) whether under normal condition or in sleep mode.

1.10 Connectors

This section describes and illustrates the rear panel and internal connectors on the motherboard.

1.10.1 Rear panel connectors

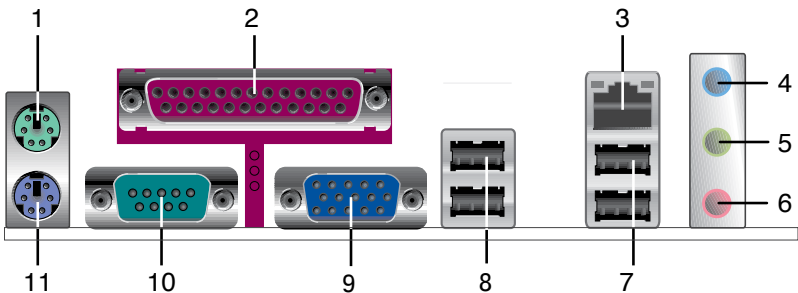

1. **PS/2 mouse port (green).** This 6-pin port is for a PS/2 mouse.
2. **Parallel port.** This 25-pin port connects a parallel printer, a scanner, or other devices.
3. **LAN (RJ-45) port.** This port allows connection to a Local Area Network (LAN) through a network hub.
4. **Line In port.** This Line In (light blue) port connects a tape player or other audio sources. In 4 or 6-channel mode, the function of this port becomes Back Surround.
5. **Line Out port.** This Line Out (lime) port connects a headphone or a speaker. In 4 or 6-channel mode, the function of this port becomes Front Speaker Out.
6. **Microphone port.** This Mic (pink) port connects a microphone. In 6-channel mode, the function of this port becomes Center/LFE.



The functions of the Line Out, Line In, and Microphone ports change when you select the 4 or 6-channel audio configuration as shown in the following table.

Audio ports function variation

Audio ports	Headphone /2-Channel	4-Channel	6-Channel
Light Blue	Line In	Back Surround	Back Surround
Lime	Line Out	Front Speaker Out	Front Speaker Out
Pink	Mic In	Mic In	Center/LFE

- 7. **USB 2.0 ports 3 and 4.** These two 4-pin Universal Serial Bus (USB) ports are available for connecting USB 2.0 devices.
- 8. **USB 2.0 ports 1 and 2.** These two 4-pin Universal Serial Bus (USB) ports are available for connecting USB 2.0 devices
- 9. **Video Graphics Adapter port.** This 15-pin port is for a VGA monitor or other VGA-compatible devices.
- 10. **Serial port.** This 9-pin COM1 port is for pointing devices or other serial devices.
- 11. **PS/2 keyboard port (purple).** This port is for a PS/2 keyboard.

1.10.2 Internal connectors

1. Floppy disk drive connector (34-1 pin FLOPPY)

This connector is for the provided floppy drive (FDD) signal cable. Insert one end of the cable to this connector, then connect the other end to the signal connector at the back of the floppy disk drive.



Pin 5 on the connector is removed to prevent incorrect cable connection when using an FDD cable with a covered Pin 5.

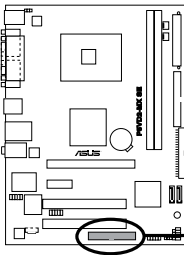

P5VD2-MX SE
Floppy Disk Drive Connector

FLOPPY

NOTE: Orient the red markings on the floppy ribbon cable to PIN 1.

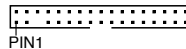

2. IDE connectors (40-1 pin PRI_IDE, SEC_IDE)

The onboard IDE connectors are for Ultra DMA 133/100/66 signal cables. There are three connectors on each Ultra DMA 133/100/66 signal cable: blue, black, and gray. Connect the blue connector to the motherboard's IDE connector, then select one of the following modes to configure your device(s).

	Drive jumper setting	Mode of devices	Cable connector
Single device	Cable-Select or Master	-	Black
Two devices	Cable-Select	Master Slave	Black Gray
	Master Slave	Master Slave	Black or gray



- Pin 20 on the IDE connector is removed to match the covered hole on the Ultra DMA cable connector. This prevents incorrect insertion when you connect the IDE cable.
- Use the 80-conductor IDE cable for Ultra DMA 133/100/66 IDE devices.



If any device jumper is set as "Cable-Select," make sure all other device jumpers have the same setting.

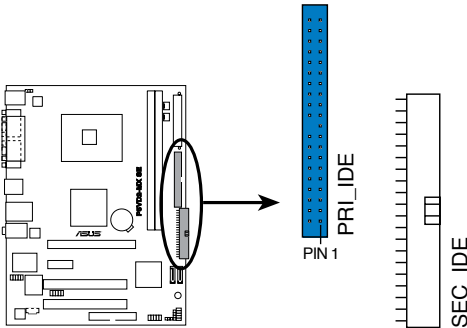

P5VD2-MX SE IDE Connectors

NOTE: Orient the red markings (usually zigzag) on the IDE ribbon cable to PIN 1.

3. Internal audio connector (4-pin CD)

This connector allows you to receive stereo audio input from sound sources such as a CD-ROM, TV tuner, or MPEG card.

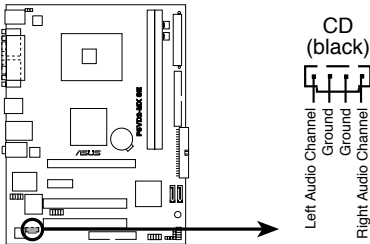

P5VD2-MX SE Internal Audio Connector

4. CPU and chassis fan connectors (3-pin CPU_FAN, CHA_FAN)

The fan connectors support cooling fans of 350mA~740mA (8.88W max.) or a total of 1A~2.22A (26.64W max.) at +12V. Connect the fan cables to the fan connectors on the motherboard, making sure that the black wire of each cable matches the ground pin of the connector.



Do not forget to connect the fan cables to the fan connectors. Insufficient air flow within the system can damage the motherboard components. These are not jumpers! DO NOT place jumper caps on the fan connectors!

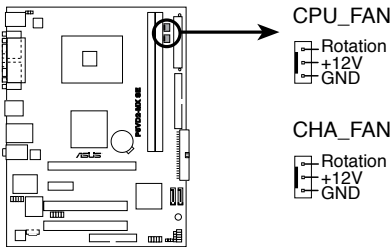

P5VD2-MX SE Fan Connectors

5. ATX power connectors (24-pin EATXPWR, 4-pin ATX12V)

These connectors are for ATX power supply plugs. The plugs from the power supply are designed to fit these connectors in only one orientation. Find the proper orientation and push down firmly until the connectors fit completely.



- Do not forget to connect the 4-pin ATX +12V power plug; otherwise, the system does not boot up.
- Make sure that your ATX 12V power supply can provide 12A on the +12V lead and at least 1A on the +5-volt standby lead (+5VSB). The minimum recommended wattage is 300 W, or 350 W for a fully configured system. The system can become unstable or will not boot up if the power is inadequate.

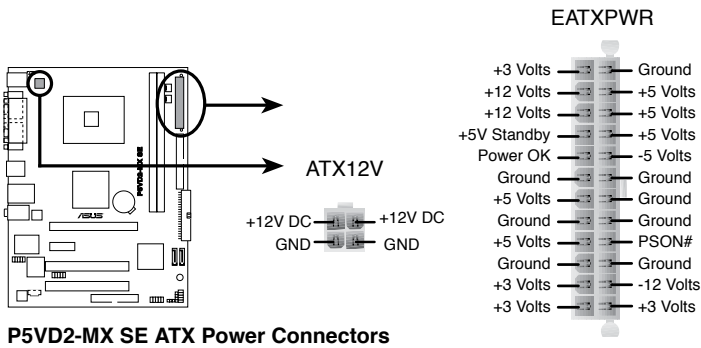

6. Speaker out connector (4-pin SPEAKER)

This connector is for the case-mounted speaker and allows you to hear system beeps and warnings.

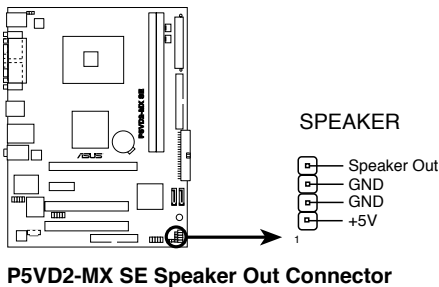

7. Serial ATA connectors (7-pin SATA1, SATA2)

These connectors support the thin Serial ATA cables for Serial ATA hard disks. If you installed Serial ATA hard disks, you may create a RAID 0, RAID 1, or JBOD configuration.

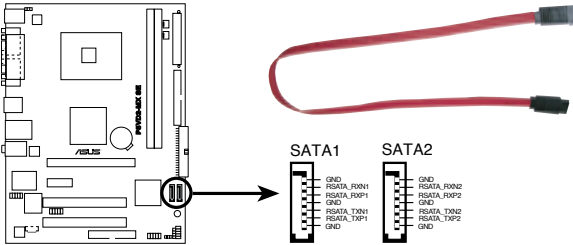

P5VD2-MX SE SATA Connectors

8. Front panel audio connector (10-1 pin AAFP)

This interface for the front panel audio cable allows convenient connection and control of audio devices.

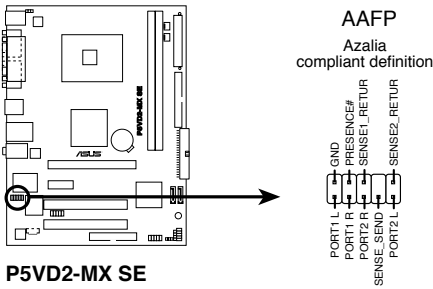

**P5VD2-MX SE
Analog Front Panel Connector**

9. USB connectors (10-1 pin USB56, USB78)

These connectors are for USB 2.0 ports. Connect the USB module cable to any of these connectors, then install the module to a slot opening at the back of the system chassis. These USB connectors comply with USB 2.0 specification that supports up to 480 Mbps connection speed.



NEVER connect a **1394 cable** to the USB connectors. Doing so will damage the motherboard!

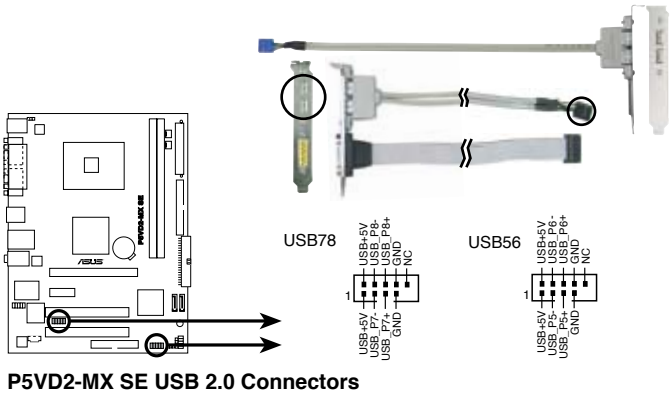

The USB module is purchased separately.

10. System panel connector (10-1 pin F_PANEL)

This connector supports several system chassis-mounted functions.

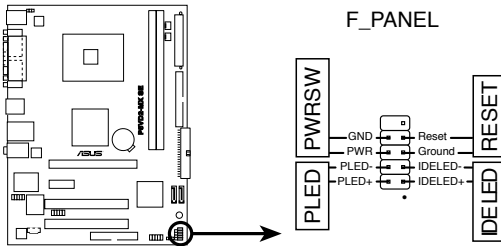

P5VD2-MX SE System Panel Connector

- **System power LED (2-pin PLED)**
This 3-pin connector is for the system power LED. Connect the chassis power LED cable to this connector. The system power LED lights up when you turn on the system power, and blinks when the system is in sleep mode.
- **Power/Soft-off button (2-pin PWRSW)**
This connector is for the system power button. Pressing the power button turns the system ON or puts the system in SLEEP or SOFT-OFF mode depending on the BIOS settings. Pressing the power switch for more than four seconds while the system is ON turns the system OFF.
- **Hard disk drive activity (2-pin IDELED)**
This 2-pin connector is for the HDD Activity LED. Connect the HDD Activity LED cable to this connector. The IDE LED lights up or flashes when data is read from or written to the HDD.
- **Reset button (2-pin RESET)**
This connector is for the chassis-mounted reset button for system reboot without turning off the system power.

Chapter 2

This chapter tells how to change system settings through the BIOS Setup menus, and provides detailed descriptions of the BIOS parameters.

BIOS Information

2.1 Managing and Updating Your BIOS

The following utilities allow you to manage and update the motherboard Basic Input/Output System (BIOS) setup.

1. **AFUDOS** (Updates the BIOS in DOS mode using a bootable floppy disk.)
2. **ASUS EZ Flash** (Updates the BIOS using a floppy disk during POST.)
3. **ASUS CrashFree BIOS 2** (Updates the BIOS using a bootable floppy disk or the motherboard support CD).

Refer to the corresponding section for each utility.



- Save a copy of the original motherboard BIOS file to a bootable floppy disk in case you need to restore the BIOS in the future. Copy the original motherboard BIOS using the AFUDOS utility.
- Refer to the system builder's website for details about updating the BIOS.

2.1.1 Creating a bootable floppy disk

1. Do either one of the following to create a bootable floppy disk.

DOS environment

Insert a 1.44MB floppy disk into the drive. At the DOS prompt, type:

format A:/S then press <Enter>.

Windows® XP environment

- a. Insert a 1.44MB floppy disk into the floppy disk drive.
 - b. From your Windows® desktop, click on **Start**, then select **My Computer**.
 - c. Select the **3 1/2 Floppy Drive** icon.
 - d. Click **File** from the menu, then select **Format**. A **Format 3 1/2 Floppy Disk** window appears.
 - e. Select **Create an MS-DOS startup disk** from the format options field, then click **Start**.
2. Copy the original (or the latest) motherboard BIOS to the bootable floppy disk.

2.1.2 Using AFUDOS to copy the current BIOS

The AFUDOS.EXE utility can also be used to copy the current system BIOS settings to a floppy or hard disk. The copy can be used as a backup in case the system BIOS fails or gets corrupted.

1. At the DOS prompt, type the command line:

afudos /o[filename]

where “filename” can be any user-provided filename of not more than eight alphanumeric characters for the main filename and three alphanumeric characters for the extension name.

Press <Enter>.



The BIOS information on the screen is for reference only. What you see on your screen may not be exactly the same as shown.

Main filename Extension name

```
A:\>afudos /oMYBIOS03.rom
AMI Firmware Update Utility - Version 1.10
Copyright (C) 2002 American Megatrends, Inc. All rights reserved.
Reading flash ..... 0x0008CC00 (9%)
```

2. The utility will copy the current system BIOS by default to the floppy disk. Make sure that the floppy disk is not write-protected and has enough space (at least 600KB) to store the file.

```
A:\>afudos /oMYBIOS03.rom
AMI Firmware Update Utility - Version 1.10
Copyright (C) 2002 American Megatrends, Inc. All rights reserved.
Reading flash ..... done

A:\>
```

When the BIOS copy process is complete, the utility returns to the DOS prompt.

2.1.3 Using AFUDOS to update the BIOS

The AFUDOS is a DOS-based application that lets you update the BIOS file using a bootable floppy diskette. AFUDOS also allows you to copy the original BIOS file to a floppy diskette.

To update the BIOS using the AFUDOS.EXE:

1. Download the latest BIOS file from the website provided by the system builder.



Write the BIOS filename on a piece of paper. You need to type the exact BIOS file name at the prompt.

2. Copy the AFUDOS.EXE utility from the support CD to the bootable floppy disk that contains the BIOS file.
3. Boot the system from the floppy disk.

- At the DOS prompt, type the command line:

afudos /i[filename.rom]

where [filename.rom] means the latest (or original) BIOS file that you copied to the bootable floppy disk.

- Press <Enter>. The screen displays the status of the update process.



The BIOS information on the screen is for reference only. What you see on your screen may not be exactly the same as shown.

```
A:\>afudos /iP5VD2MX.rom
AMI Firmware Update Utility - Version 1.10
Copyright (C) 2002 American Megatrends, Inc. All rights reserved.
  Reading file .... done
  Erasing flash ... done
  Writing flash ... 0x0008CC00 (9%)
```



DO NOT shut down or reset the system while updating the BIOS! Doing so can cause system boot failure!

When the BIOS update process is complete, the utility returns to the DOS prompt.

```
A:\>afudos /iP5VD2MX.rom
AMI Firmware Update Utility - Version 1.10
Copyright (C) 2002 American Megatrends, Inc. All rights reserved.
  Reading file .... done
  Erasing flash ... done
  Writing flash ... 0x0008CC00 (9%)
  Verifying flash .. done
A:\>
```

- Reboot the system from the hard disk.

2.1.4 ASUS CrashFree BIOS 2 utility

The ASUS CrashFree BIOS 2 is an auto recovery tool that allows you to restore the BIOS file when it fails or gets corrupted during the updating process. You can update a corrupted BIOS file using the motherboard support CD or the floppy disk that contains the updated BIOS file.



- Prepare the motherboard support CD or the floppy disk containing the updated motherboard BIOS before using this utility.
- Make sure that you rename the original or updated BIOS file in the floppy disk to **P5VD2MX.ROM**.

Recovering the BIOS from a floppy disk

To recover the BIOS from a floppy disk:

1. Turn on the system.
2. Insert the floppy disk with the original or updated BIOS file to the floppy disk drive.
3. The utility displays the following message and automatically checks the floppy disk for the original or updated BIOS file.

```
Bad BIOS checksum. Starting BIOS recovery...  
Checking for floppy...
```

When found, the utility reads the BIOS file and starts flashing the corrupted BIOS file.

```
Bad BIOS checksum. Starting BIOS recovery...  
Checking for floppy...  
Floppy found!  
Reading file "P5VD2MX.ROM". Completed.  
Start flashing...
```



DO NOT shut down or reset the system while updating the BIOS! Doing so can cause system boot failure!

4. Restart the system after the utility completes the updating process.

Recovering the BIOS from the support CD

To recover the BIOS from the support CD:

1. Remove any floppy disk from the floppy drive, then turn on the system.
2. Insert the support CD to the optical drive.
3. The utility displays the following message and automatically checks the floppy disk for the original or updated BIOS file.

```
Bad BIOS checksum. Starting BIOS recovery...
Checking for floppy...
```

When no floppy disk is found, the utility automatically checks the optical drive for the original or updated BIOS file. The utility then updates the corrupted BIOS file.

```
Bad BIOS checksum. Starting BIOS recovery...
Checking for floppy...
Floppy not Found!
Checking for CD-ROM...
CD-ROM found!
Reading file "P5VD2MX.ROM". Completed.
Start flashing...
```



DO NOT shut down or reset the system while updating the BIOS! Doing so can cause system boot failure!

4. Restart the system after the utility completes the updating process.



The recovered BIOS may not be the latest BIOS version for this motherboard. Visit the ASUS website (www.asus.com) to download the latest BIOS file.

2.1.5 Using ASUS EZ Flash to update the BIOS

The ASUS EZ Flash feature allows you to easily update the BIOS without having to go through the long process of booting from a floppy disk and using a DOS-based utility. The EZ Flash is built-in the BIOS LPC chip so it is accessible by simply pressing <Alt> + <F2> during the Power-On Self Tests (POST).

To update the BIOS using ASUS EZ Flash:

1. Visit the system builder website to download the latest BIOS file for your motherboard and rename it to **P5VD2MX.ROM**. Save the BIOS file to a floppy disk.
2. Reboot the system.
3. To launch EZ Flash, press <Alt> + <F2> during POST to display the following.

```
User recovery requested. Starting BIOS recovery...
Checking for floppy...
```



- If there is no floppy disk in the drive, the error message "Floppy not found!" appears.
- If the correct BIOS file is not found in the floppy disk, the error message "P5VD2MX.ROM not found!" is displayed.

4. Insert the floppy disk that contains the BIOS file. If the **P5VD2MX.ROM** file is found in the floppy disk, EZ Flash performs the BIOS update process and automatically reboots the system when done.



DO NOT shut down or reset the system while updating the BIOS! Doing so can cause system boot failure!

```
User recovery requested. Starting BIOS recovery...
Checking for floppy...
Floppy found!
Reading file "P5VD2MX.ROM". Completed.
Start flashing...
Flashed successfully. Rebooting.
```

2.2 BIOS Setup Program



The BIOS software is constantly being updated so the BIOS setup screens and descriptions in this section are for reference purposes only, and may not exactly match what you see on your screen.

This motherboard supports a programmable Low Pin Count (LPC) chip that you can update using the provided utility described in section “2.1 Managing and updating your BIOS.”

Use the BIOS Setup program when you are installing a motherboard, reconfiguring your system, or prompted to “Run Setup”. This section explains how to configure your system using this utility.

Even if you are not prompted to use the Setup program, you can change the configuration of your computer in the future. For example, you can enable the security password feature or make changes to the power management settings. This requires you to reconfigure your system using the BIOS Setup program so that the computer can recognize these changes and record them in the CMOS RAM of the LPC chip.

The LPC chip on the motherboard stores the Setup utility. When you start up the computer, the system provides you with the opportunity to run this program. Press during the Power-On Self-Test (POST) to enter the Setup utility; otherwise, POST continues with its test routines.

To enter Setup after POST, restart the system by pressing <Ctrl> + <Alt> + , or by pressing the reset button on the system chassis. You can also restart by turning the system off and then back on. Do this last option only if the first two fail.

The Setup program is designed to make it as easy to use as possible. Being a menu-driven program, it lets you scroll through the various sub-menus and make your selections among the predetermined choices.

2.2.1 BIOS menu screen

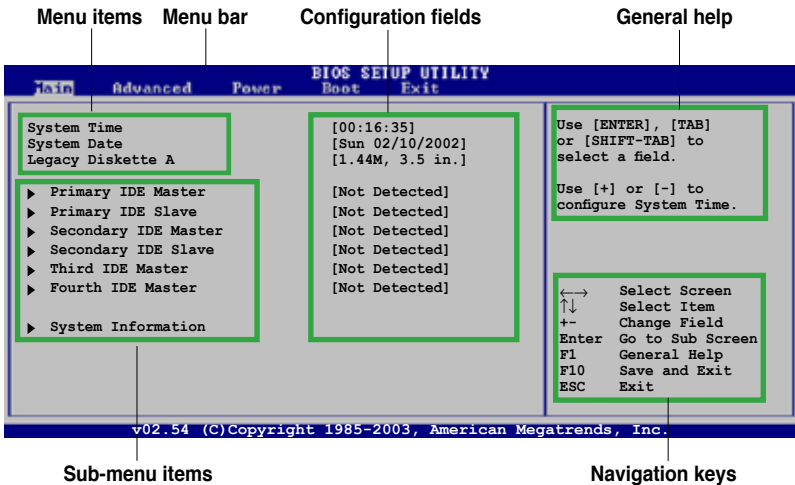

2.2.2 Menu bar

The menu bar on top of the screen has the following main items:

- Main** For changing the basic system configuration
- Advanced** For changing the advanced system settings
- Power** For changing the advanced power management (APM) configuration
- Boot** For changing the system boot configuration
- Exit** For selecting the exit options and loading default settings

To select an item on the menu bar, press the right or left arrow key on the keyboard until the desired item is highlighted.

2.2.3 Navigation keys

At the bottom right corner of a menu screen are the navigation keys for that particular menu. Use the navigation keys to select items in the menu and change the settings.



Some of the navigation keys differ from one screen to another.

2.2.4 Menu items

The highlighted item on the menu bar displays the specific items for that menu. For example, selecting **Main** shows the Main menu items.

The other items (Advanced, Power, Boot, and Exit) on the menu bar have their respective menu items.

2.2.5 Sub-menu items

A solid triangle before each item on any menu screen means that the item has a sub-menu. To display the sub-menu, select the item, then press <Enter>.

2.2.6 Configuration fields

These fields show the values for the menu items. If an item is user-configurable, you can change the value of the field opposite the item. You cannot select an item that is not user-configurable.

A configurable field is enclosed in brackets, and is highlighted when selected. To change the value of a field, select it then press <Enter> to display a list of options. Refer to “2.2.7 Pop-up window”.

2.2.7 Pop-up window

Select a menu item then press <Enter> to display a pop-up window with the configuration options for that item.

2.2.8 Scroll bar

A scroll bar appears on the right side of a menu screen when there are items that do not fit on the screen. Press the Up/Down arrow keys or <PageUp> / <PageDown> keys to display the other items on the screen.

2.2.9 General help

At the top right corner of the menu screen is a brief description of the selected item.

2.3 Main Menu

When you enter the BIOS Setup program, the Main menu screen appears, giving you an overview of the basic system information.



Refer to section “2.2.1 BIOS menu screen” for information on the menu screen items and how to navigate through them.

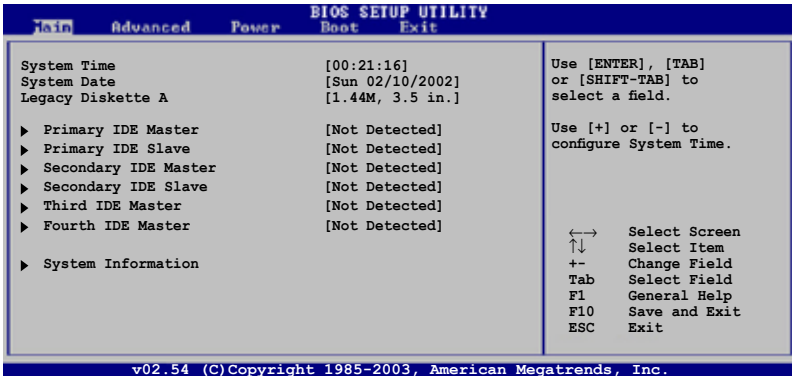

2.3.1 System Time [xx:xx:xx]

Allows you to set the system time.

2.3.2 System Date [Day xx/xx/xxxx]

Allows you to set the system date.

2.3.3 Legacy Diskette A [1.44M, 3.5 in.]

Sets the type of floppy drive installed. Configuration options: [Disabled] [360K, 5.25 in.] [1.2M, 5.25 in.] [720K, 3.5 in.] [1.44M, 3.5 in.] [2.88M, 3.5 in.]

2.3.4 Primary, Secondary Master/Slave, Third, Fourth IDE Master

While entering Setup, BIOS automatically detects the presence of IDE devices. There is a separate sub-menu for each IDE device. Select a device item then press <Enter> to display the IDE device information.



The BIOS automatically detects the values opposite the dimmed items (Device, Vendor, Size, LBA Mode, Block Mode, PIO Mode, Async DMA, Ultra DMA, and SMART monitoring). These values are not user-configurable. These items show N/A if no IDE device is installed in the system.

Type [Auto]

Selects the type of IDE drive.

Configuration options: [Auto] [Not Installed] [CDROM] [ARMD]

LBA/Large Mode [Auto]

Enables or disables the LBA/Large mode. Setting to Auto enables the LBA/Large mode if the device supports this mode, and if the device was not previously formatted with LBA mode disabled. Configuration options: [Auto] [Disabled]

Block (Multi-Sector Transfer) [Auto]

Enables or disables data multi-sectors transfers. When set to Auto, the data transfer from and to the device occurs multiple sectors at a time if the device supports multi-sector transfer feature. When set to Disabled, the data transfer from and to the device occurs one sector at a time.

Configuration options: [Auto] [Disabled]

PIO Mode [Auto]

Selects the PIO mode. Configuration options: [Auto] [0] [1] [2] [3] [4]

DMA Mode [Auto]

Selects the DMA mode. Configuration options: [Auto] [SWDMA0] [SWDMA1] [SWDMA2] [MWDMA0] [MWDMA1] [MWDMA2] [UDMA0] [UDMA1] [UDMA2] [UDMA3] [UDMA4] [UDMA5]

SMART Monitoring [Auto]

Sets the Smart Monitoring, Analysis, and Reporting Technology. Configuration options: [Auto] [Disabled] [Enabled]

32Bit Data Transfer [Enabled]

Enables or disables 32-bit data transfer. Configuration options: [Disabled] [Enabled]

2.3.5 System Information

This menu gives you an overview of the general system specifications. The items in this menu are auto-detected by the BIOS.

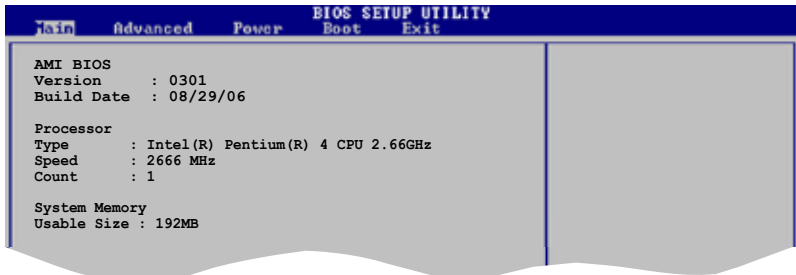

AMI BIOS

Displays the auto-detected BIOS information.

Processor

Displays the auto-detected CPU specification

System Memory

Displays the auto-detected system memory.

2.4 Advanced menu

The Advanced menu items allow you to change the settings for the CPU and other system devices.



Take caution when changing the settings of the Advanced menu items. Incorrect field values can cause the system to malfunction.

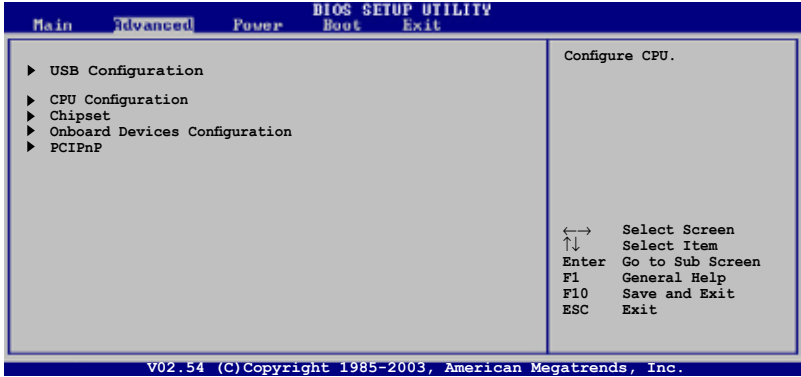

2.4.1 USB Configuration

The items in this menu allows you to change the USB-related features. Select an item then press <Enter> to display the configuration options.

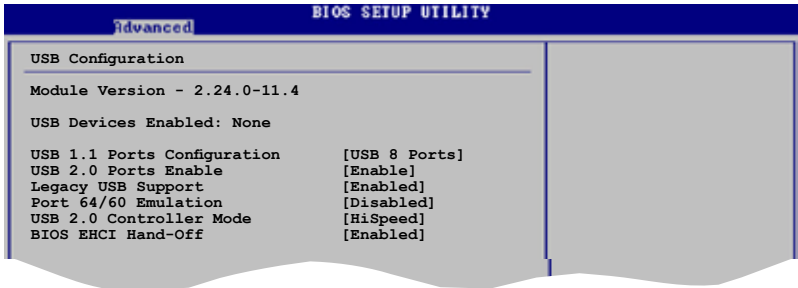

The Module Version and USB Devices Enabled items show the auto-detected values. If no USB device is detected, the item shows None.

USB 1.1 Ports Configuration [USB 8 Ports]

Allows you to disable or enable the USB 1.1 ports configuration.

Configuration options: [Disabled] [USB 2 Ports] [USB 4 Ports] [USB 6 Ports] [USB 8 Ports]

USB 2.0 Ports Enable [Enable]

Allows you to disable or enable the USB 2.0 ports enable.

Configuration options: [Disabled] [Enabled]

Legacy USB Support [Enabled]

Allows you to enable or disable support for USB devices on legacy operating systems (OS). Setting to Auto allows the system to detect the presence of USB devices at startup. If detected, the USB controller legacy mode is enabled. If no USB device is detected, the legacy USB support is disabled.

Configuration options: [Disabled] [Enabled] [Auto]

Port 64/60 Emulation [Disabled]

Allows you to enable or disable the I/O port 60h/64h emulation support.

Configuration options: [Enabled] [Disabled]

USB 2.0 Controller Mode [HiSpeed]

Allows you to configure the USB 2.0 controller in HiSpeed (480 Mbps) or Full Speed (12 Mbps). Configuration options: [HiSpeed] [Full Speed]

BIOS EHCI Hand-off [Enabled]

Allows you to enable support for operating systems without an EHCI hand-off feature. Configuration options: [Enabled] [Disabled]



Do not disable the BIOS EHCI Hand-Off option if you are running a Windows® operating system with USB device.

2.4.2 CPU Configuration

The items in this menu show the CPU-related information that the BIOS automatically detects.

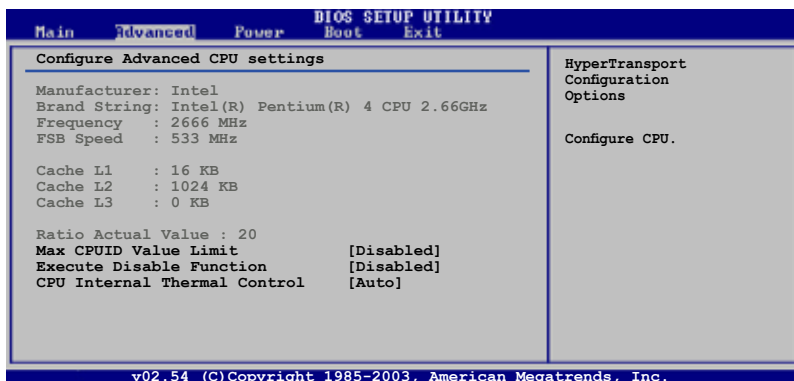

Max CPUID Value Limit [Disabled]

Enable this item to boot legacy operating systems that cannot support CPUs with extended CPUID functions.

Configuration options: [Disabled] [Enabled]

Execute Disable Function [Disabled]

Enables or disables the Execute Disable function. This item appears only when you install a processor with the Execute Disable function.

Configuration options: [Disabled] [Enabled]

CPU Internal Thermal Control [Auto]

Disables or sets the CPU internal thermal control.

Configuration options: [Disabled] [Auto]

2.4.3 Chipset

The Chipset menu allows you to change the advanced chipset settings. Select an item then press <Enter> to display the sub-menu.

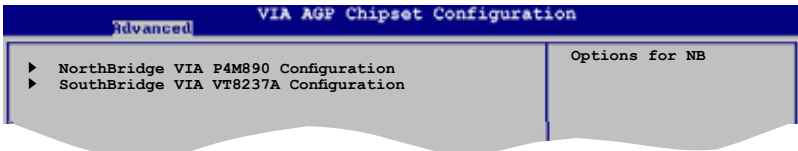

NorthBridge Configuration

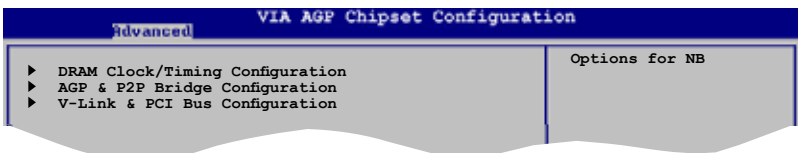

DRAM Frequency/Timing Configuration

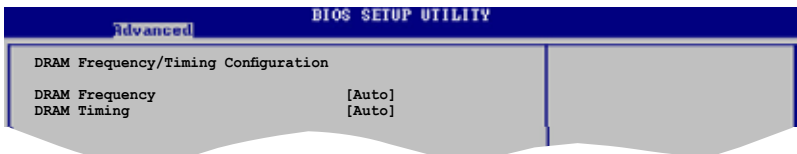

DRAM Frequency [Auto]

Sets the DRAM frequency. Configuration options: [Auto] [200 MHz] [266 MHz] [333 MHz] [400 MHz] [533MHz]

DRAM Timing [Auto]

Sets the DRAM Timing mode. Configuration options: [Auto] [Manual] [Turbo] [Ultra]



The following item appears when the **DRAM Timing** item is set to [Manual].

DRAM CAS# Latency [DDR/DDR2] [2.5/4]

Controls the latency between the SDRAM read command and the time the data actually becomes available. Configuration options: [1.5/2] [2.0/3] [2.5/4] [3.0/5] [Precharge to active] [Active to precharge] [Active to CMD]

AGP & P2P Bridge Configuration

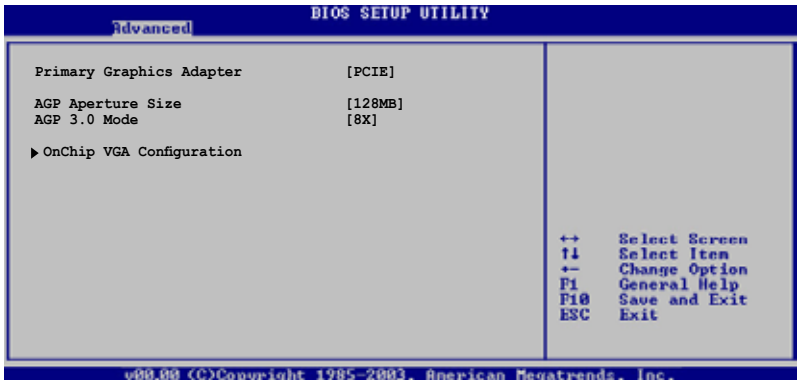

Primary Graphics Adapter [PCIE]

Allows selection of the graphics controller to use as a primary boot device.
Configuration options: [PC] [Onboard VGA] [PCIE]

AGP Aperture Size [128MB]

Allows selection of the AGP aperture size.
Configuration options: [32MB] [64MB] [128MB] [256MB] [512MB] [1GB]

AGP 3.0 Mode [8X]

Allows selection of the AGP 3.0 mode.
Configuration options: [8X] [4X]

OnChip VGA Configuration

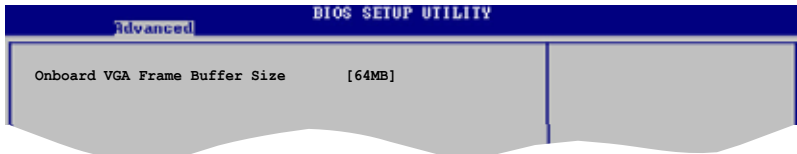

Onboard VGA Frame Buffer Size [64MB]

Set the Onboard VGA Frame Buffer Size.
Configuration options: [64MB] [128MB]

SouthBridge Configuration

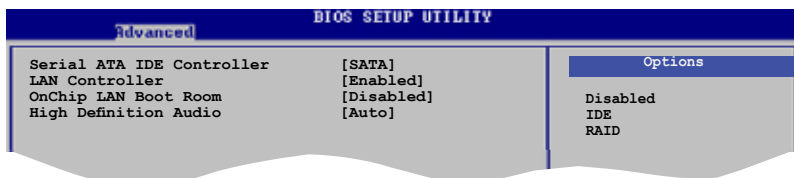

Serial ATA IDE Controller [SATA]

This option allows you to set the Serial ATA IDE controller mode.

Configuration options: [Disabled] [SATA] [RAID]

LAN Controller [Enabled]

This option allows you to enable or disable the LAN controller.

Configuration options: [Disabled] [Enabled]

OnChip LAN Boot Room [Disabled]

This option allows you to enable or disable the OnChip LAN Boot Room.

Configuration options: [Disabled] [Enabled]

High Definition Audio [Auto]

This option allows you to set the High Definition Audio.

Configuration options: [Disabled] [Auto]

2.4.4 Onboard Devices Configuration

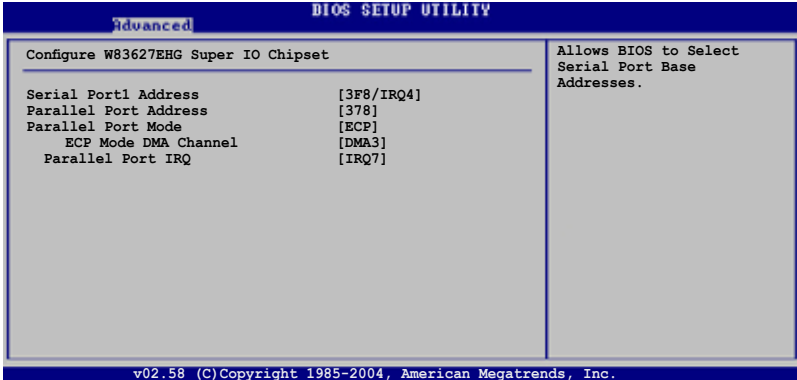

Serial Port1 Address [3F8/IRQ4]

Allows you to select the Serial Port2 base address.

Configuration options: [Disabled] [3F8/IRQ4] [2F8/IRQ3] [3E8/IRQ4] [2E8/IRQ3]

Parallel Port Address [378]

Allows you to select the Parallel Port base addresses.

Configuration options: [Disabled] [378] [278] [3BC]

Parallel Port Mode [ECP]

Allows you to select the Parallel Port mode. When the item Parallel Port Address is set to 3BC, the Parallel Port Mode options are only Normal, Bi-directional, and ECP.

Configuration options: [Normal] [Bi-directional] [EPP] [ECP]

ECP Mode DMA Channel [DMA3]

Allows selection of the Parallel Port ECP DMA channel.

Configuration options: [DMA0] [DMA1] [DMA3]

Parallel Port IRQ [IRQ7]

Allows you to select the Parallel Port IRQ.

Configuration options: [IRQ5] [IRQ7]

2.4.5 PCI PnP

The PCI PnP menu items allow you to change the advanced settings for PCI/PnP devices. The menu includes setting IRQ and DMA channel resources for either PCI/PnP or legacy ISA devices.



Take caution when changing the settings of the PCIPnP menu items. Incorrect field values can cause the system to malfunction.

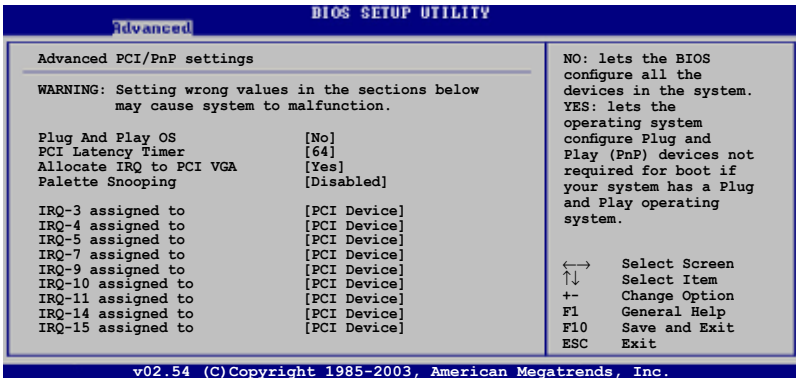

Plug And Play O/S [No]

When set to [No], BIOS configures all the devices in the system. When set to [Yes] and if you installed a Plug and Play operating system, the operating system configures the Plug and Play devices not required for boot. Configuration options: [Yes] [No]

PCI Latency Timer [64]

Allows you to select the value in units of PCI clocks for the PCI device latency timer register. Configuration options: [32] [64] [96] [128] [160] [192] [224] [248]

Allocate IRQ to PCI VGA [Yes]

When set to [Yes], BIOS assigns an IRQ to PCI VGA card if the card requests for an IRQ. When set to [No], BIOS does not assign an IRQ to the PCI VGA card even if requested. Configuration options: [No] [Yes]

Palette Snooping [Disabled]

When set to [Enabled], the palette snooping feature informs the PCI devices that an ISA graphics device is installed in the system so that the latter can function correctly. Configuration options: [Disabled] [Enabled]

IRQ xx [PCI Device]

When set to [PCI Device], the specific IRQ is free for use of PCI/PnP devices. When set to [Reserved], the IRQ is reserved for legacy ISA devices. Configuration options: [PCI Device] [Reserved]

2.5 Power menu

The Power menu items allow you to change the power settings. Select an item then press <Enter> to display the configuration options.

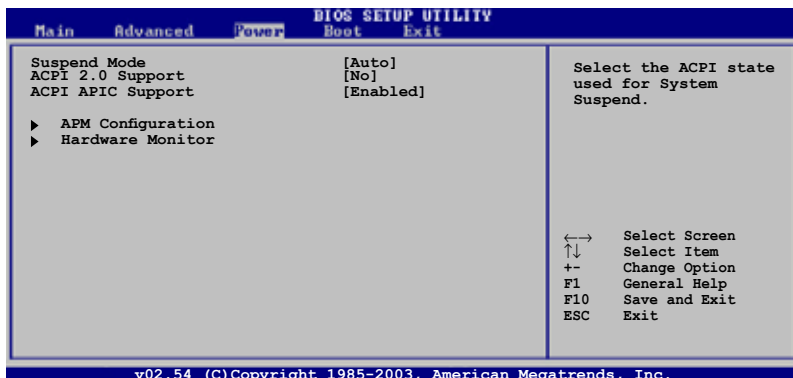

2.5.1 Suspend Mode [Auto]

Allows you to select the Advanced Configuration and Power Interface (ACPI) state to be used for system suspend.

Configuration options: [S1 (POS) Only] [S3 Only] [Auto]

2.5.1 ACPI 2.0 Support [No]

Allows you to add more tables for ACPI 2.0 specifications.

Configuration options: [No] [Yes]

2.5.2 ACPI APIC Support [Enabled]

Enables or disables the ACPI support in the ASIC. When set to Enabled, the ACPI APIC table pointer is included in the RSDT pointer list.

Configuration options: [Disabled] [Enabled]

2.5.3 APM Configuration

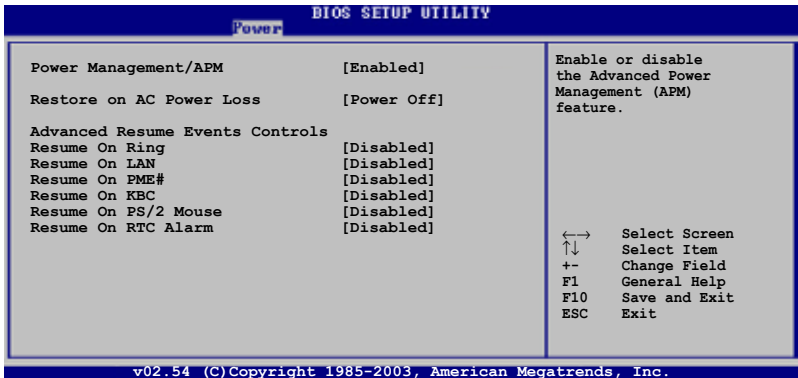

Power Management/APM [Enabled]

Allows you to enable or disable the Advanced Power Management (APM) feature. Configuration options: [Disabled] [Enabled]

Restore on AC Power Loss [Power Off]

When set to Power Off, the system goes into off state after an AC power loss. When set to Power On, the system goes on after an AC power loss. When set to Last State, the system goes into either off or on state whatever was the system state before the AC power loss.

Configuration options: [Last State] [Power Off] [Power On]

Resume On Ring [Disabled]

Allows you to enable or disable Resume On Ring. Configuration options: [Disabled] [Enabled]

Resume On Lan [Disabled]

Allows you to enable or disable the Resume On Lan. Configuration options: [Disabled] [Enabled]

Resume On PME [Disabled]

Allows you to enable or disable the Resume On PME. Configuration options: [Enabled] [Disabled]

ResumeOn KBC [Disabled]

Allows you to use specific keys on the keyboard to turn on the system. When set to [S5], the item Wake-up Key is enabled. This feature requires an ATX power supply that provides at least 1A on the +5VSB lead. Configuration options: [Disabled] [Enabled]

Resume On PS/2 Mouse [Disabled]

When set to [Enabled], this parameter allows you to use the PS/2 mouse to resume the system. This feature requires an ATX power supply that provides at least 1A on the +5VSB lead. Configuration options: [Disabled] [Enabled]

Resume On RTC Alarm [Disabled]

When set to [Enabled], this option allows you to use the RTC alarm to turn on the system. Configuration options: [Enabled] [Disabled]

2.5.4 Hardware Monitor

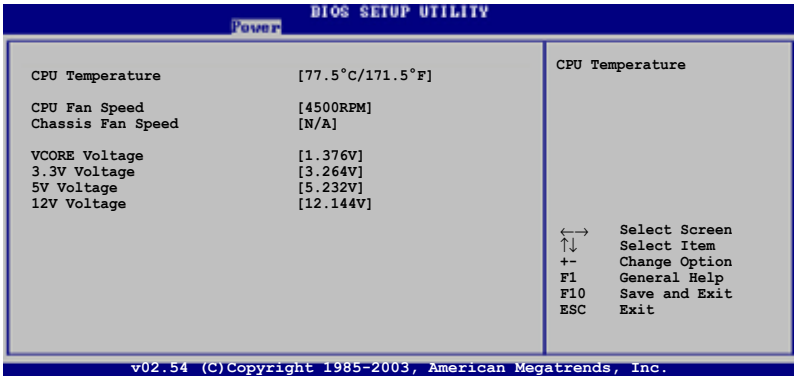

CPU Temperature [xxx°C/xxx°F]

The onboard hardware monitor automatically detects and displays the CPU and motherboard temperatures.

CPU Fan Speed [xxxxRPM]

The onboard hardware monitor automatically detects and displays the CPU fan speed in rotations per minute (RPM). If the fan is not connected to the motherboard, the specific field shows N/A. Configuration options: [xxxxRPM] [N/A] [Ignored]

Chassis Fan Speed [xxxxRPM] or [N/A]

The onboard hardware monitor automatically detects and displays the chassis fan speed in rotations per minute (RPM). If the fan is not connected to the chassis, the specific field shows N/A.

Configuration options: [Ignored] [xxxRPM] or [N/A]

VCORE Voltage, 3.3V Voltage, 5V Voltage, 12V Voltage

The onboard hardware monitor automatically detects the voltage output through the onboard voltage regulators.

2.6 Boot menu

The Boot menu items allow you to change the system boot options. Select an item then press <Enter> to display the sub-menu.

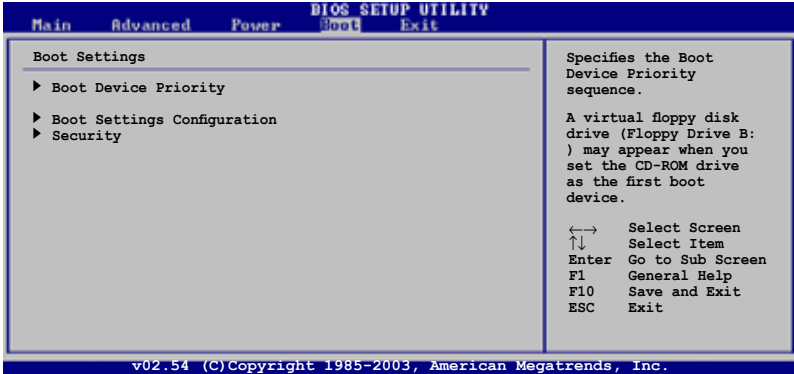

The hidden option **Removable Drives** will display if any removable boot device is detected.

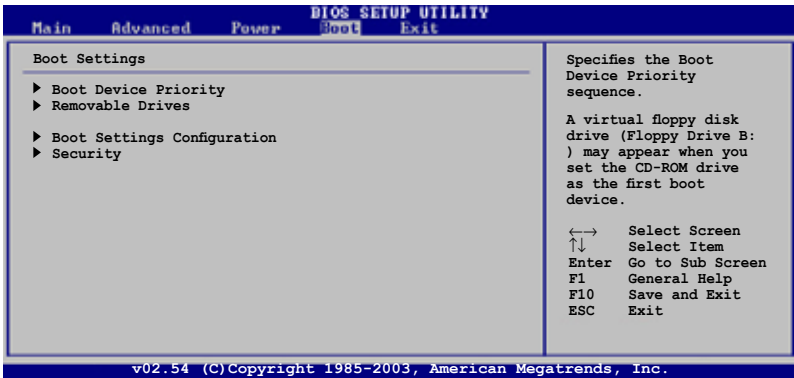

2.6.1 Boot Device Priority

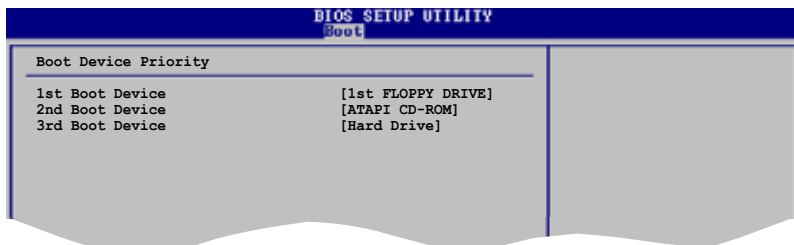

1st ~ xxth Boot Device [1st FLOPPY DRIVE]

These items specify the boot device priority sequence from the available devices. The number of device items that appear on the screen depends on the number of devices installed in the system. Configuration options: [1st FLOPPY Drive] [ATAPI CD-ROM] [Hard Drive] [Disabled]

2.6.2 Boot Settings Configuration

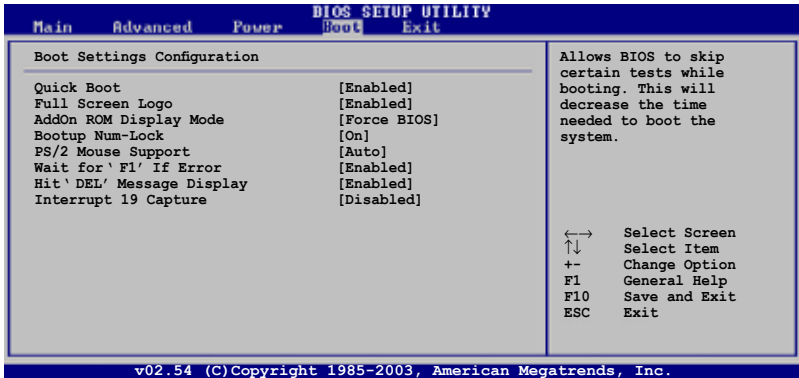

Quick Boot [Enabled]

Enabling this item allows BIOS to skip some power on self tests (POST) while booting to decrease the time needed to boot the system. When set to [Disabled], BIOS performs all the POST items. Configuration options: [Enabled] [Disabled]

Full Screen Logo [Enabled]

Allows you to enable or disable the full screen logo display feature. Configuration options: [Enabled] [Disabled]



Set this item to [Enabled] to use the ASUS MyLogo2™ feature.

AddOn ROM Display Mode [Force BIOS]

Sets the display mode for option ROM. Configuration options: [Force BIOS] [Keep Current]

Bootup Num-Lock [On]

Allows you to select the power-on state for the NumLock. Configuration options: [On] [Off]

PS/2 Mouse Support [Auto]

Allows you to enable or disable support for PS/2 mouse. Configuration options: [Auto] [Disabled] [Enabled]

Wait for 'F1' If Error [Enabled]

When set to [Enabled], the system waits for F1 key to be pressed when error occurs. Configuration options: [Enabled] [Disabled]

Hit 'DEL' Message Display [Enabled]

When set to [Enabled], the system displays the message "Press DEL to run Setup" during POST. Configuration options: [Enabled] [Disabled]

Interrupt 19 Capture [Disabled]

When set to [Enabled], this function allows the option ROMs to trap Interrupt 19. Configuration options: [Disabled] [Enabled]

2.6.3 Security

The Security menu items allow you to change the system security settings. Select an item then press <Enter> to display the configuration options.

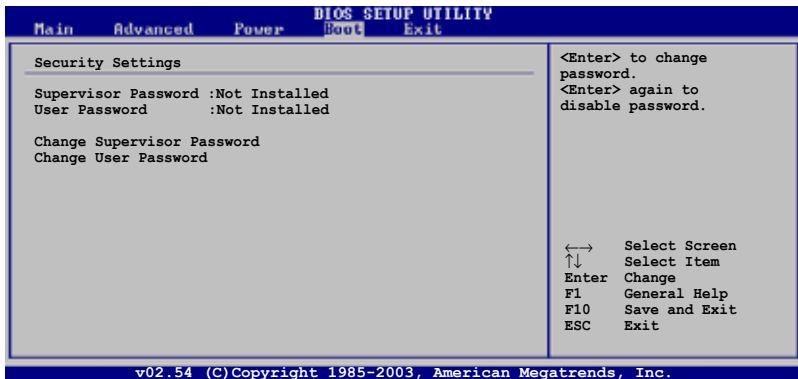

Change Supervisor Password

Select this item to set or change the supervisor password. The Supervisor Password item on top of the screen shows the default **Not Installed**. After you have set a password, this item shows **Installed**.

To set a Supervisor Password:

1. Select the Change Supervisor Password item and press <Enter>.
2. On the password box that appears, type a password composed of at least six letters and/or numbers, then press <Enter>.
3. Confirm the password when prompted.

The message "Password Installed" appears after you successfully set your password. The Supervisor Password item now shows "Installed". To change the supervisor password, follow the same steps as in setting a user password.

To clear the supervisor password, select the Change Supervisor Password then press Enter. The message "Password Uninstalled" appears.

To clear the supervisor password, select the Change Supervisor Password then press Enter. The message "Password Uninstalled" appears.

After you have set a supervisor password, the other items appear to allow you to change other security settings.

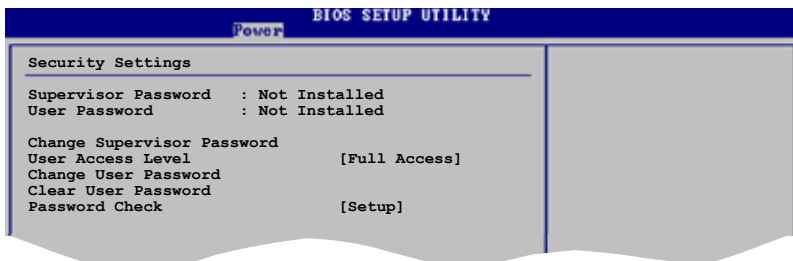

User Access Level [Full Access]

This item allows you to select the access restriction to the Setup items. Configuration options: [No Access] [View Only] [Limited] [Full Access]

No Access prevents user access to the Setup utility.

View Only allows access but does not allow change to any field.

Limited allows changes only to selected fields, such as Date and Time.

Full Access allows viewing and changing all the fields in the Setup utility.

Change User Password

Select this item to set or change the user password. The User Password item on top of the screen shows the default Not Installed. After you set a password, this item shows Installed.

To set a User Password:

1. Select the Change User Password item and press <Enter>.
2. On the password box that appears, type a password composed of at least six letters and/or numbers, then press <Enter>.
3. Confirm the password when prompted.

The message "Password Installed" appears after you set your password successfully.

To change the user password, follow the same steps as in setting a user password.

Change User Password

Select this item to set or change the user password. The User Password item on top of the screen shows the default Not Installed. After you set a password, this item shows Installed.

To set a User Password:

1. Select the Change User Password item and press <Enter>.
2. On the password box that appears, type a password composed of at least six letters and/or numbers, then press <Enter>.
3. Confirm the password when prompted.

The message “Password Installed” appears after you set your password successfully.

To change the user password, follow the same steps as in setting a user password.

2.7 Exit menu

The Exit menu items allow you to load the optimal or failsafe default values for the BIOS items, and save or discard your changes to the BIOS items.

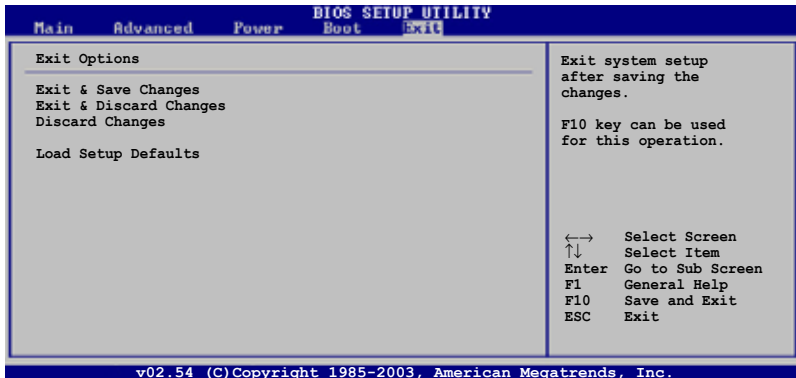

Pressing <Esc> does not immediately exit this menu. Select one of the options from this menu or <F10> from the legend bar to exit.

Exit & Save Changes

Once you are finished making your selections, choose this option from the Exit menu to ensure the values you selected are saved to the CMOS RAM. The CMOS RAM is sustained by an onboard backup battery and stays on even when the PC is turned off. When you select this option, a confirmation window appears. Select [OK] to save changes and exit.



If you attempt to exit the Setup program without saving your changes, the program prompts you with a message asking if you want to save your changes before exiting. Pressing <Enter> saves the changes while exiting.

Exit & Discard Changes

Select this option only if you do not want to save the changes that you made to the Setup program. If you made changes to fields other than system date, system time, and password, the BIOS asks for a confirmation before exiting.

Discard Changes

This option allows you to discard the selections you made and restore the previously saved values. After selecting this option, a confirmation appears. Select [OK] to discard any changes and load the previously saved values.

Load Setup Defaults

This option allows you to load the default values for each of the parameters on the Setup menus. When you select this option, or if you press <F5>, a confirmation window appears. Select [OK] to load the default values. Select Exit & Save Changes or make other changes before saving the values to the non-volatile RAM.

Chapter 3

This chapter describes the contents of the support CD that comes with the motherboard package.

Software Support

3.1 Installing an operating system

This motherboard supports Windows® 2000/XP operating systems (OS). Always install the latest OS version and corresponding updates to maximize the features of your hardware.



Motherboard settings and hardware options vary. Use the setup procedures presented in this chapter for reference only. Refer to your OS documentation for detailed information.

3.2 Support CD information

The support CD that came with the motherboard package contains the drivers, software applications, and utilities that you can install to avail all motherboard features.



The contents of the support CD are subject to change at any time without notice. Visit the ASUS website(www.asus.com) for updates.

3.2.1 Running the support CD

Place the support CD to the optical drive. The CD automatically displays the Drivers menu if Autorun is enabled in your computer.



Click an icon to display support CD/motherboard information

Click an item to install



If Autorun is NOT enabled in your computer, browse the contents of the support CD to locate the file ASSETUP.EXE from the BIN folder. Double-click the ASSETUP.EXE to run the CD.

3.2.2 Drivers menu

The drivers menu shows the available device drivers if the system detects installed devices. Install the necessary drivers to activate the devices.

VIA 4 in 1 Drivers

Install VIA 4 in 1 drivers.

VIA Onboard VGA Driver

Install VIA Onboard VGA driver.

Realtek Audio Driver

Install Realtek Audio driver.

VIA Rhine Family Fast Ethernet Adapter Driver

Install VIA Rhine Family Fast Ethernet Adapter driver.

VIA RAID Driver

Install VIA RAID driver.



The screen display and drivers option may not be the same for different operating system versions.

3.2.3 Utilities menu

The Utilities menu shows the applications and other softwares that the motherboard supports.



ASUS PC Probe II

This smart utility monitors the fan speed, CPU temperature, and system voltages, and alerts you of any detected problems. This utility helps you keep your computer in healthy operating condition.

ASUS Update

The ASUS Update utility allows you to update the motherboard BIOS in Windows® environment. This utility requires an Internet connection either through a network or an Internet Service Provider (ISP).

ADOBE Acrobat Reader V7.0

The Adobe Acrobat® Reader V7.0 is for opening, viewing, and printing documents in Portable Document Format (PDF).

Microsoft DirectX 9.0c Driver

The Microsoft DirectX® 9.0c is a multimedia technology that enhances computer graphics and sounds. DirectX® improves the multimedia features of your computer so you can enjoy watching TV and movies, capturing videos, or playing games in your computer.

Anti-virus Utility

The anti-virus utility scans, identifies, and removes computer viruses. View the online help for detailed information.

ASUS Screen Saver

Bring life to your computer screen by installing the ASUS screen saver.

3.2.4 Make disk menu

The Utilities menu shows you to make a RAID driver disk.



Make VIA RAID Driver

Allows you to create a VT8237A 32/64bit RAID driver disk.

3.2.5 Manuals menu

The Manuals menu contains a list of supplementary user manuals. Click an item to open the folder of the user manual.



Most user manual files are in Portable Document Format (PDF). Install the Adobe® Acrobat® Reader from the Utilities menu before opening a user manual file.



VIA8237 SATA Quick setup User's Manual

Allows you to open the VIA8237 SATA quick setup user's manual.

3.2.6 ASUS Contact information

Click the Contact tab to display the ASUS contact information. You can also find this information on the inside front cover of this user guide.

